

GRM033R71E562ME14#

"#" indicates a package specification code.



< List of part numbers with package codes >

GRM033R71E562ME14D , GRM033R71E562ME14W , GRM033R71E562ME14J

Shape

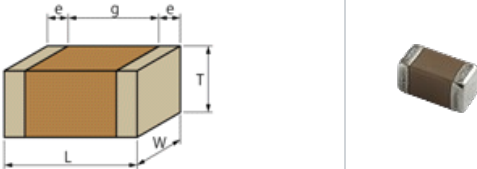

L size	0.6 ±0.03mm
W size	0.3 ±0.03mm
T size	0.3 ±0.03mm
External terminal width e	0.1 to 0.2mm
Distance between external terminals g	0.2mm min.
Size code in inch(mm)	0201 (0603M)

Notes

Derating1

References

Packaging	Specifications	Minimum quantity
D	φ180mm Paper taping	15000
J	φ330mm Paper taping	50000
W	φ180mm Paper taping (W8P1*) * Width : 8mm, Pocket pitch : 1mm	30000

Mass (typ.)	
1 piece	0.33mg
φ180mm Reel	118g

Specifications

Capacitance	5600pF ±20%
Rated voltage	25Vdc
Temperature characteristics (complied standard)	X7R(EIA)
Capacitance change rate	±15.0%
Temperature range of temperature characteristics	-55 to 125°C
Operating temperature range	-55 to 125°C

Attention

1.This datasheet is downloaded from the website of Murata Manufacturing Co., Ltd. Therefore, it's specifications are subject to change or our products in it may be discontinued without advance notice. Please check with our sales representatives or product engineers before ordering.

2.This datasheet has only typical specifications because there is no space for detailed specifications.

Therefore, please review our product specifications or consult the approval sheet for product specifications before ordering.