

Slide Switches, Instrumentation Grade

SEE PAGE B20 FOR PRODUCT SPECIFICATIONS

4P3T



MSS4300R

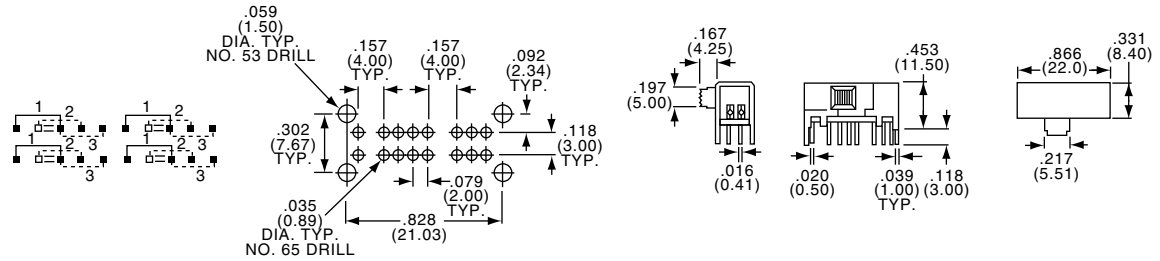

Tyco Electronics	Alcoswitch	Plating
7-1437576-7	MSS4300R	Silver
7-1437576-8	MSS4300RG	Gold

4P3T



MSS4350R

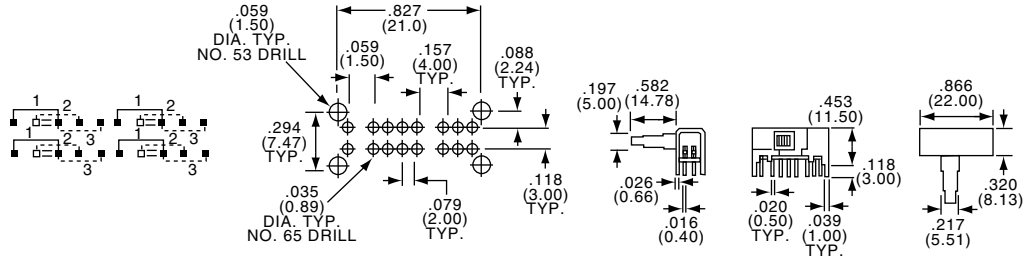

Tyco Electronics	Alcoswitch	Plating
8-1437576-0	MSS4350R	Silver
8-1437576-1	MSS4350RG	Gold

6PDT



MSS6200

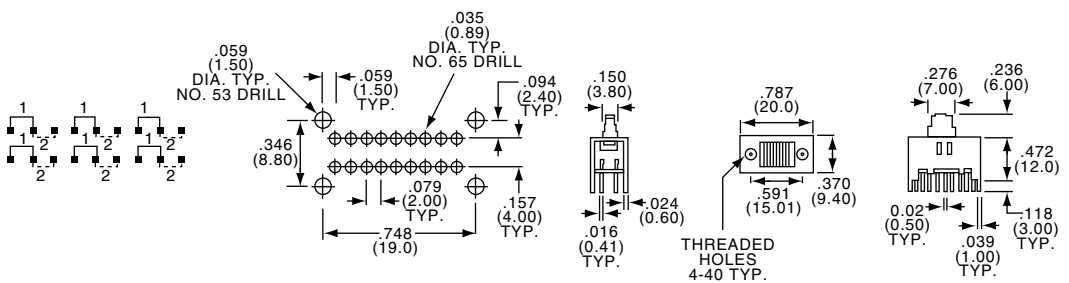

Tyco Electronics	Alcoswitch	Plating
8-1437576-8	MSS6200	Silver
8-1437576-9	MSS6200G	Gold

B
MSS Series

Slide Switches, Instrumentation Grade

SEE PAGE B20 FOR PRODUCT SPECIFICATIONS

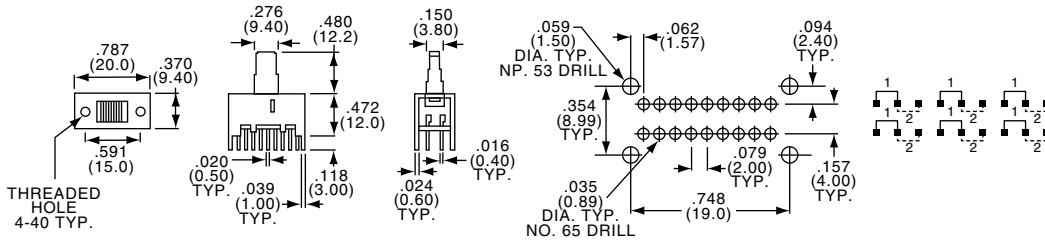

6PDT



MSS6250

Tyco Electronics	Alcoswitch	Plating
9-1437576-0	MSS6250	Silver

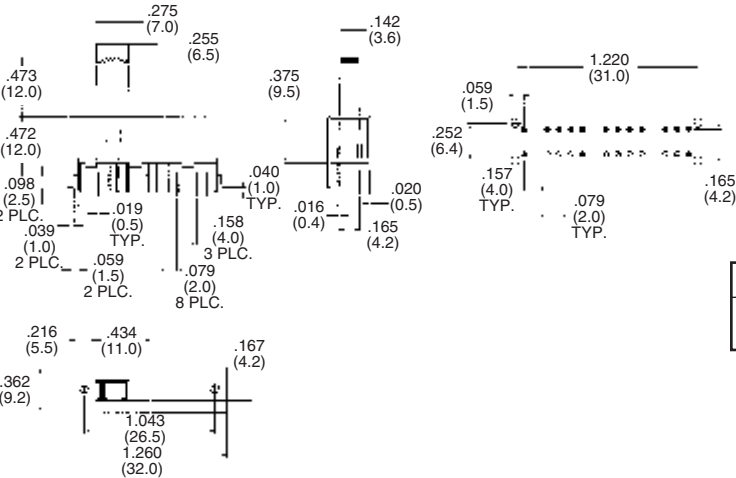

Tyco Electronics	Alcoswitch	Plating
9-1437576-3	MSS6350	Silver
—	MSS6350G	Gold

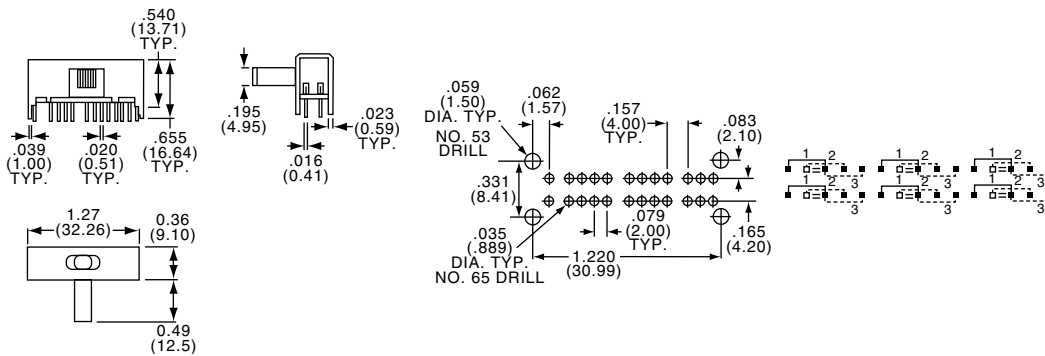

6P3T



MSS6350R

Tyco Electronics	Alcoswitch	Plating
9-1437576-4	MSS6350R	Silver
—	MSS6350RG	Gold

Slide Switches, Instrumentation Grade

MATERIAL SPECIFICATIONS:

ContactsSilver or gold over copper alloy
 Case MaterialCold rolled steel
 Actuator MaterialPolyester UL94V-0
 Terminals/Fixed Contacts.....Gold or silver plate over copper alloy
 Terminal SealEpoxy

ENVIRONMENTAL SPECIFICATIONS:

Operating Temperature.....-4°F to +185°F (-20°C to +85°C)
 Storage Temperature.....-40°F to +212°F (-40°C to +100°C)
 Solder Heat Resistance.....See page M3-4

TYPICAL PERFORMANCE CHARACTERISTICS:

Contact RatingGold: 0.4 VA 20 VDC or peak AC
 Silver: 300 mA @ 125 VAC
 Initial Contact Resistance30 Milliohms max.
 Contact Timing.....Make before break
 Insulation Resistance1,000 Megohms min.
 Dielectric Strength500 Volts RMS @ sea level
 Actuation Force600±300/470 Grams average
 Actuator Travel.....0.079" (2.01) approximate
 Life ExpectancyUp to 15,000 Cycles

B
MSSA Series

SP3T

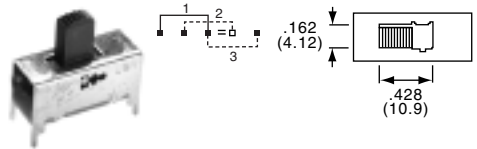

MSSA1350

Tyco Electronics	Alcoswitch	Plating	Mounting Style
3-1437580-3	MSSA1350	Silver	Upright
3-1437580-4	MSSA1350G	Gold	Upright

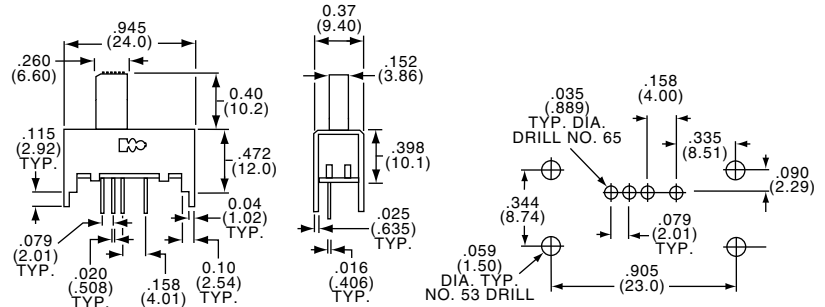

SP3T

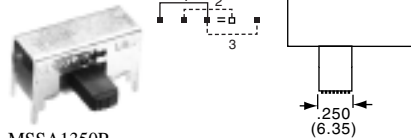

MSSA1350R

Tyco Electronics	Alcoswitch	Plating	Mounting Style
3-1437580-5	MSSA1350R	Silver	Rt. Angle
3-1437580-6	MSSA1350RG	Gold	Rt. Angle

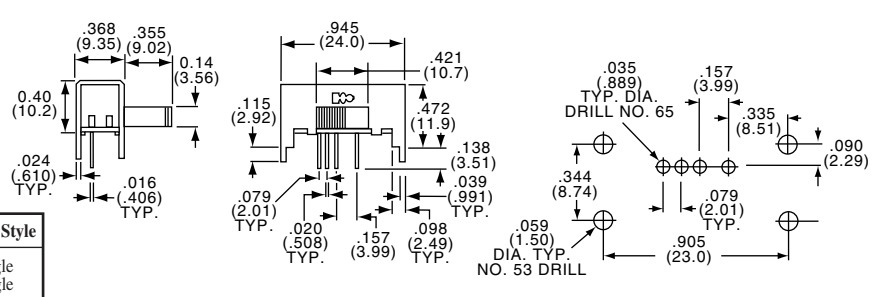

SP4T



MSSA1450

Tyco Electronics	Alcoswitch	Plating	Mounting Style
3-1437580-7	MSSA1450	Silver	Upright
3-1437580-8	MSSA1450G	Gold	Upright

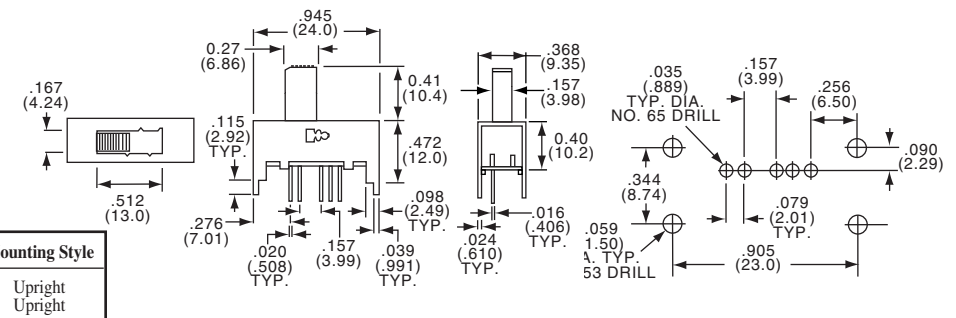

SP4T

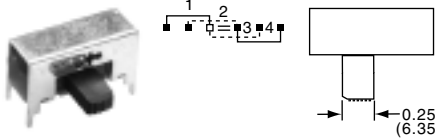

MSSA1450R

Tyco Electronics	Alcoswitch	Plating	Mounting Style
3-1437580-9	MSSA1450R	Silver	Rt. Angle
4-1437580-0	MSSA1450RG	Gold	Rt. Angle

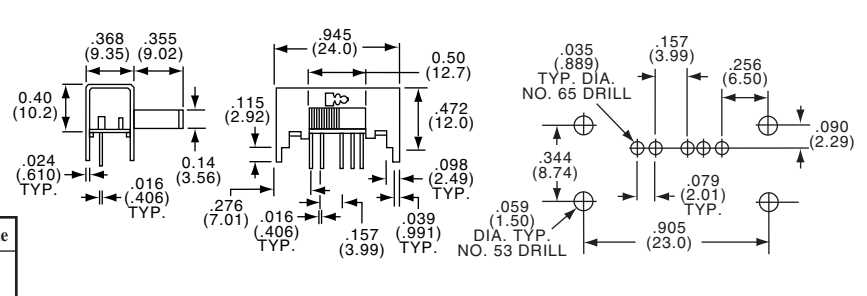

Slide Switches, Instrumentation Grade

SEE PAGE B26 FOR PRODUCT SPECIFICATIONS

DP3T

MSSA2350

Dimensions: .167 (4.24), .428 (10.9), .079 (2.01) TYP., .276 (7.01), .115 (2.92), .945 (24.0), .027 (6.86), .472 (12.0), .041 (10.4), .138 (3.51), .098 (2.49) TYP., .099 (2.49) TYP., .020 (.508) TYP., .157 (3.99), .039 (.991) TYP., .368 (9.35), .157 (3.99), .040 (10.2), .016 (.406) TYP., .024 (.610) TYP., .165 (4.19), .035 (.889) TYP. DIA. NO. 65 DRILL, .157 (3.99), .090 (2.29), .335 (8.51), .344 (8.74), .059 (1.50) TYP. DIA. NO. 53 DRILL, .079 (2.01) TYP., .165 (4.19), .905 (23.0)

Pin Configurations: 1 2 3, 1 2 3, 1 2 3

Tyco Electronics	Alcoswitch	Plating	Mounting Style
5-1437580-3	MSSA2350	Silver	Upright
5-1437580-4	MSSA2350G	Gold	Upright

DP3T

MSSA2350R

Dimensions: 0.25 (6.35), .276 (7.01), .079 (2.01) TYP., .115 (2.92), .945 (24.0), .421 (10.7), .472 (12.0), .138 (3.51), .098 (2.49) TYP., .099 (2.49) TYP., .020 (.508) TYP., .157 (3.99), .039 (.991) TYP., .368 (9.35), .355 (9.02), .014 (3.56), .024 (.610) TYP., .016 (.406) TYP., .035 (.889) TYP. DIA. NO. 65 DRILL, .157 (3.99), .090 (2.29), .335 (8.51), .344 (8.74), .059 (1.50) TYP. DIA. NO. 53 DRILL, .079 (2.01) TYP., .165 (4.19), .905 (23.0)

Pin Configurations: 1 2 3, 1 2 3, 1 2 3

Tyco Electronics	Alcoswitch	Plating	Mounting Style
5-1437580-5	MSSA2350R	Silver	Rt. Angle
5-1437580-6	MSSA2350RG	Gold	Rt. Angle

DP4T

MSSA2450

Dimensions: .368 (9.35), .167 (4.24), .512 (13.0), .270 (6.86), .945 (24.0), .410 (10.4), .472 (12.0), .115 (2.92), .020 (.50) TYP., .039 (1.00) TYP., .157 (3.99), .016 (.406) TYP., .016 (.406) TYP., .035 (.889) TYP. DIA. NO. 65 DRILL, .157 (3.99), .090 (2.29), .256 (6.50), .344 (8.74), .059 (1.50) TYP. DIA. NO. 53 DRILL, .079 (2.01) TYP., .165 (4.19), .905 (23.0)

Pin Configurations: 1 2 3 4, 1 2 3 4, 1 2 3 4

Tyco Electronics	Alcoswitch	Plating	Mounting Style
5-1437580-7	MSSA2450	Silver	Upright
5-1437580-8	MSSA2450G	Gold	Upright

DP4T

MSSA2450R

Dimensions: 0.25 (6.35), .115 (2.92), .945 (24.0), .050 (12.7), .472 (12.0), .138 (3.51), .098 (2.49) TYP., .099 (2.49) TYP., .016 (.406) TYP., .276 (7.01), .157 (3.99), .039 (.991) TYP., .368 (9.35), .355 (9.02), .014 (3.56), .024 (.610) TYP., .016 (.406) TYP., .035 (.889) TYP. DIA. NO. 65 DRILL, .157 (3.99), .090 (2.29), .256 (6.50), .344 (8.74), .059 (1.50) TYP. DIA. NO. 53 DRILL, .079 (2.01) TYP., .165 (4.19), .905 (23.0)

Pin Configurations: 1 2 3 4, 1 2 3 4, 1 2 3 4

Tyco Electronics	Alcoswitch	Plating	Mounting Style
5-1437580-9	MSSA2450R	Silver	Rt. Angle
6-1437580-0	MSSA2450RG	Gold	Rt. Angle

Slide Switches, Instrumentation Grade

SEE PAGE B26 FOR PRODUCT SPECIFICATIONS

3P3T



MSSA3350

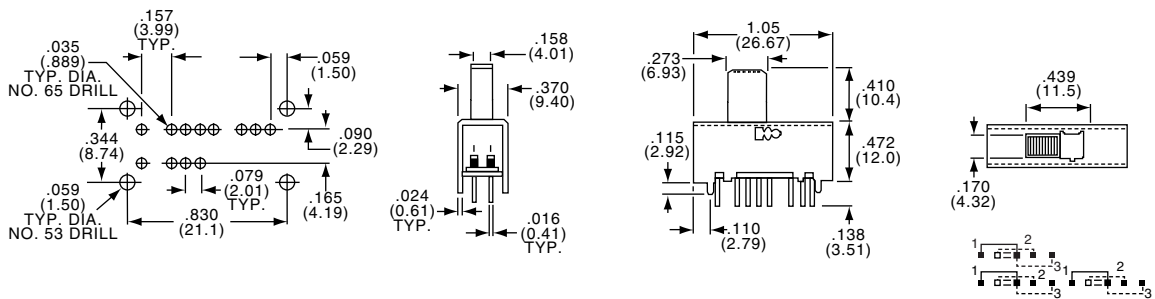

Tyco Electronics	Alcoswitch	Plating	Mounting Style
6-1437580-1	MSSA3350	Silver	Upright
6-1437580-2	MSSA3350G	Gold	Upright

3P3T



MSSA3350R

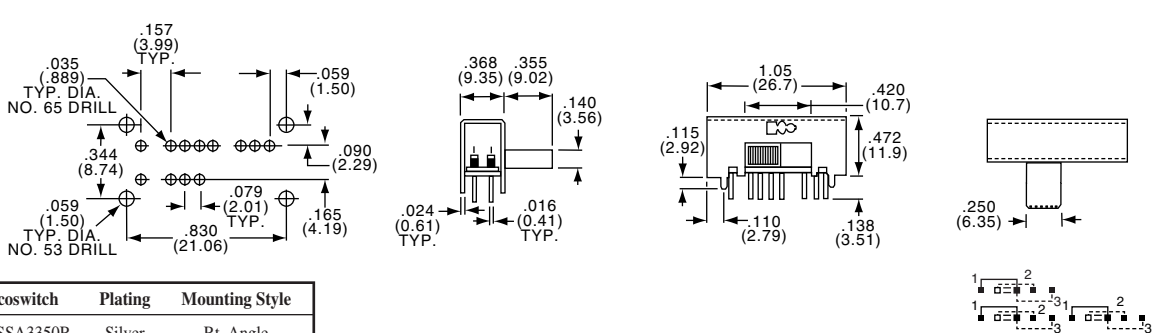

Tyco Electronics	Alcoswitch	Plating	Mounting Style
6-1437580-3	MSSA3350R	Silver	Rt. Angle
6-1437580-4	MSSA3350RG	Gold	Rt. Angle

3P4T



MSSA3450

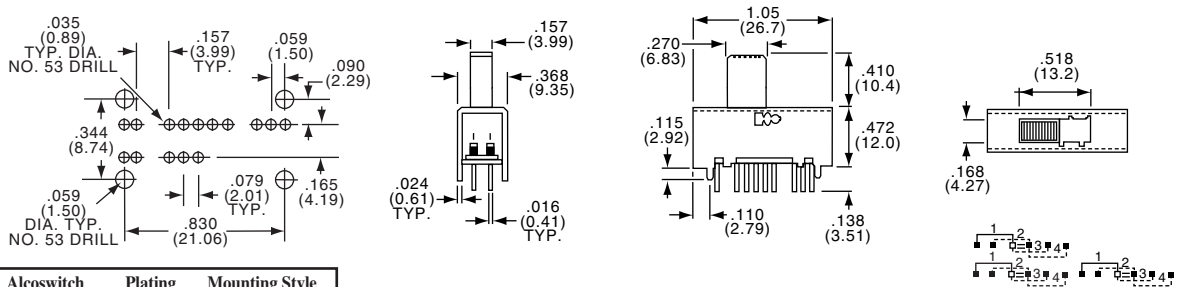

Tyco Electronics	Alcoswitch	Plating	Mounting Style
6-1437580-5	MSSA3450	Silver	Upright
6-1437580-6	MSSA3450G	Gold	Upright

3P4T



MSSA3450R

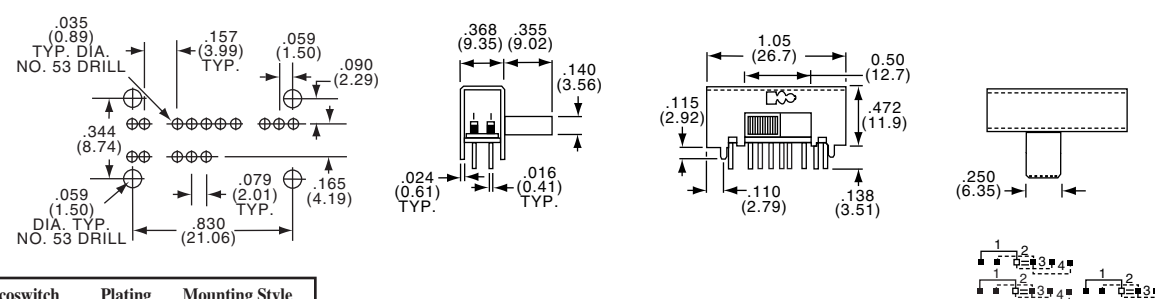

Tyco Electronics	Alcoswitch	Plating	Mounting Style
6-1437580-7	MSSA3450R	Silver	Rt. Angle
6-1437580-8	MSSA3450RG	Gold	Rt. Angle

Slide Switches, Instrumentation Grade

SEE PAGE B26 FOR PRODUCT SPECIFICATIONS

4P3T

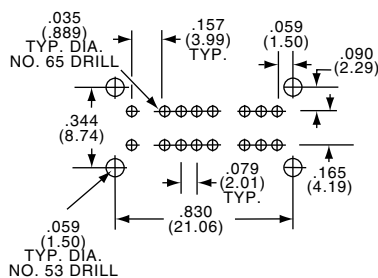
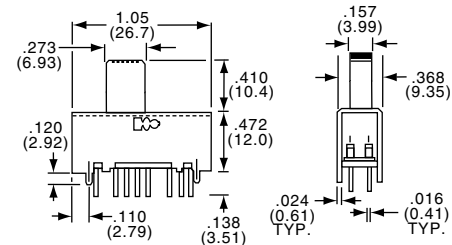
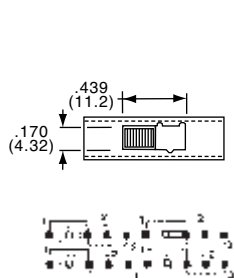

MSSA4350

Tyco Electronics	Alcoswitch	Plating	Mounting Style
6-1437580-9	MSSA4350	Silver	Upright
7-1437580-0	MSSA4350G	Gold	Upright

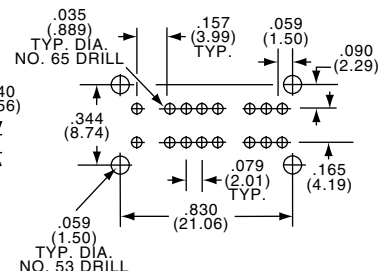
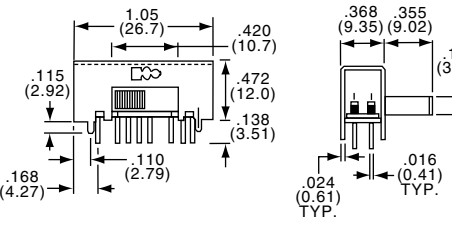
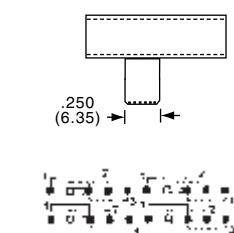

MSSA4350R

Tyco Electronics	Alcoswitch	Plating	Mounting Style
7-1437580-1	MSSA4350R	Silver	Rt. Angle
7-1437580-2	MSSA4350RG	Gold	Rt. Angle

4P3T

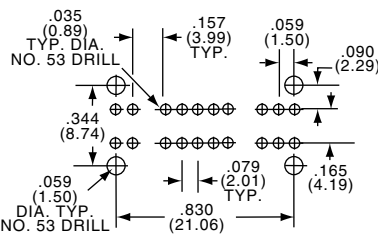
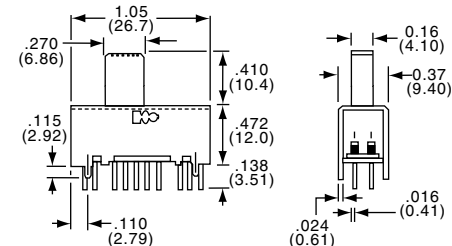
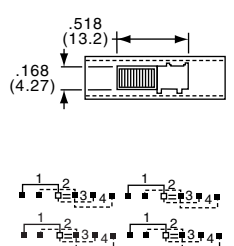

MSSA4450

Tyco Electronics	Alcoswitch	Plating	Mounting Style
7-1437580-3	MSSA4450	Silver	Upright
7-1437580-4	MSSA4450G	Gold	Upright

4P4T

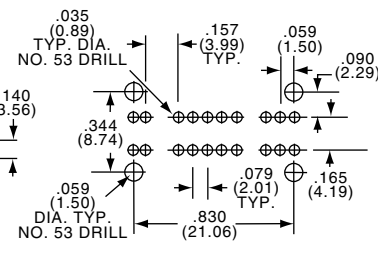
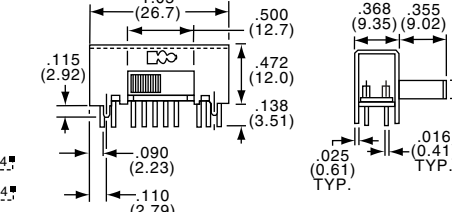
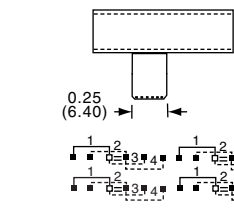

MSSA4450R

Tyco Electronics	Alcoswitch	Plating	Mounting Style
7-1437580-5	MSSA4450R	Silver	Rt. Angle
7-1437580-6	MSSA4450RG	Gold	Rt. Angle

4P4T

