

DC Brushless Motor Drivers
**Multifunction Three-phase Full-wave
 Fan Motor Driver**
BD63441AFU
●General Description

BD63441AFU is a three-phase sensorless fan motor driver that is suited for speed controllable fans.

It features a sensorless drive which doesn't require a hall device as a location detection sensor. Furthermore, there is a PWM soft switched driving mechanism for silent operation and low vibrations.

●Features

- Pre-driver compatible for external Tr.
- Sensorless drive and PWM soft switching
- Under voltage lock out (UVLO)
- Rotational speed control by DC input voltage
- Current limit
- Soft start
- Lock protection and automatic restart
- Quick start
- Rotational speed pulse signal (FG) output

●Applications

- For 12V fan motors for desktop PC, server, and general consumer equipment.

●Package(s)

SSOP-C20

W(Typ.) x D(Typ.) x H(Max.)

5.00mm x 6.40mm x 1.35mm

●Absolute maximum ratings

Parameter	Symbol	Limit	Unit
Supply voltage	Vcc	20	V
Power dissipation	Pd	874.7 ^{*1}	mW
Operating temperature range	Topr	-25 to +95	°C
Storage temperature range	Tstg	-55 to +150	°C
Output voltage	Voh	20	V
Output current	Io	10 ⁻²	mA
FG signal output voltage	Vfg	20	V
FG signal output current	I _{fg}	10	mA
BEMF input voltage (U,V,W,COM)	V _{bemf}	18	V
Input voltage (MIN, TH, SS, OSC, TOSC, RNF)	V _{in}	7	V
Junction temperature	T _{jmax}	150	°C

*1 Derate by 7.0mW/°C when operating above Ta=25°C. (On 70.0mm×70.0mm×1.6mm glass epoxy board)

*2 Pd should not be exceeded

●Recommended operating conditions

Parameter	Symbol	Limit	Unit
Operating supply voltage range	Vcc	5.5 to 16.0	V
Operating input voltage range (TH)	V _{th}	0 to V _{ref}	V
Operating input voltage range (MIN)	V _{MIN}	V _{oscl} to V _{ref}	V

●Pin Configuration

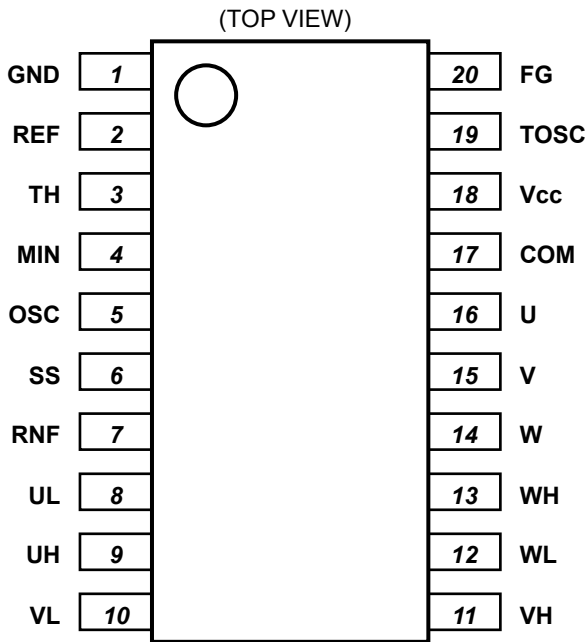

Fig.1 Pin configuration

●Pin Description

P/No.	T/Name	Function
1	GND	Ground terminal
2	REF	Reference voltage terminal
3	TH	Variable speed input terminal
4	MIN	Minimum rotating speed setting terminal
5	OSC	Oscillating capacitor connecting terminal for output PWM operation
6	SS	Soft start capacitor connecting terminal
7	RNF	Output current detecting terminal
8	UL	Low side output terminal (Motor output U)
9	UH	High side output terminal (Motor output U)
10	VL	Low side output terminal (Motor output V)
11	VH	High side output terminal (Motor output V)
12	WL	Low side output terminal (Motor output W)
13	WH	High side output terminal (Motor output W)
14	W	Motor output W detection terminal
15	V	Motor output V detection terminal
16	U	Motor output U detection terminal
17	COM	Coil midpoint terminal
18	Vcc	Power supply terminal
19	TOSC	Oscillating capacitor connecting terminal for start adjustment
20	FG	Rotating speed pulse signal output terminal

●Block Diagram

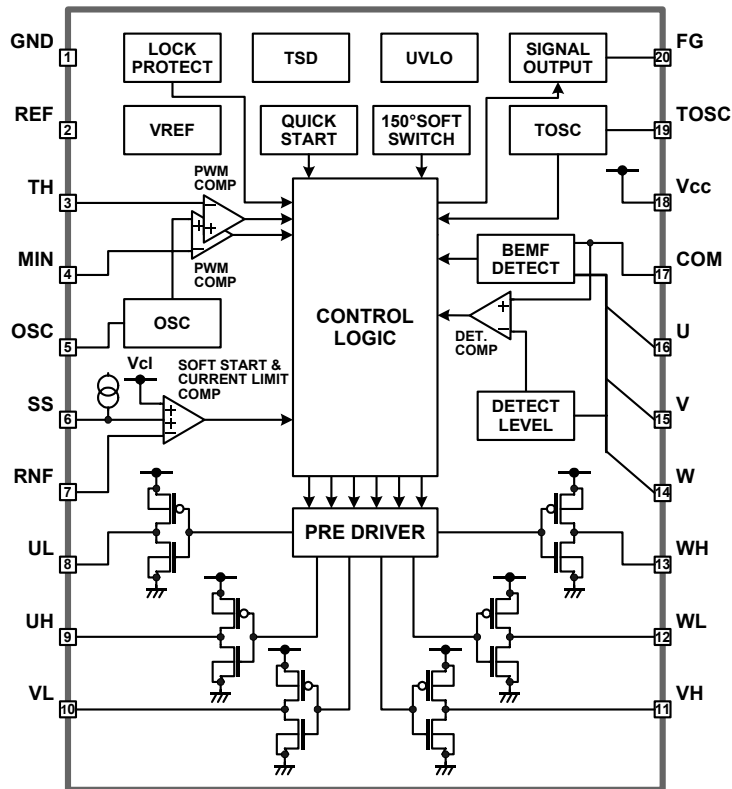

Fig.2 Block diagram

● Electrical characteristic (Unless otherwise specified Ta=25°C,Vcc=12V)

Parameter	Symbol	Limit			Unit	Conditions	Ref. data
		Min	Typ	Max			
Circuit current	Icc	4	7	10	mA		Fig.3
<REF>							
REF voltage	Vref	4.65	5.00	5.35	V	Iref=-2mA	Fig.4, 5
<TOSC>							
TOSC high voltage	Vtosch	2.3	2.5	2.7	V		Fig.6
TOSC low voltage	Vtoscl	0.80	1.05	1.20	V		Fig.6
TOSC Charge current	Ictosc	-80	-60	-40	μA	Vtosc=1.8V	Fig.7
TOSC Discharge current	Idtosc	40	60	80	μA	Vtosc=1.8V	Fig.7
<TH, MIN>							
TH input bias current	Ith	-	-	-1	μA	Vth=1.5V	Fig.8
MIN input bias current	Imin	-	-	-1	μA	Vmin=1.5V	Fig.9
<OSC>							
OSC high voltage	Vosch	2.3	2.5	2.7	V		Fig.10
OSC low voltage	Voscl	0.80	1.05	1.20	V		Fig.10
OSC charge current	Icosc	-40	-30	-20	μA	Vosc=1.8V	Fig.11
OSC discharge current	Idosc	20	30	40	μA	Vosc=1.8V	Fig.11
<Internal current limit>							
Current limit voltage	Vcl	120	150	180	mV		Fig.12
RNF input bias current	Irnf	-	-	-1	μA	Vrnf=0V	Fig.13
<Soft Start function>							
SS charge current	Icss	-300	-120	-50	nA	Vss=0V	Fig.14
<FG>							
FG low voltage	Vfgl	-	0.3	0.4	V	Ifg=5mA	Fig.15, 16
FG leak current	Ifgl	-	-	10	μA	Vfg=20V	Fig.17
<Lock protection>							
Lock detect ON time	Ton	0.3	0.5	0.8	s		Fig.18
Lock detect OFF time	Toff	3	5	8	s		Fig.19
<Output>							
Hi side output Hi voltage	Vohh	Vcc-0.2	-	Vcc	V	Iohh=0mA	Fig.20, 21
Hi side output Lo voltage	Vohl	0.3	0.5	0.7	V	Iohl=1mA	Fig.22, 23
Lo side output Hi voltage	Volh	Vcc-0.7	Vcc-0.5	Vcc-0.3	V	Iolh=-1mA	Fig.24, 25
Lo side output Lo voltage	Voll	0	-	0.2	V	Ioll=0mA	Fig.26, 27

About current items, inflow current to IC is denoted by a positive sign, and outflow current from IC is denoted by a negative sign.

● Typical Performance Curves (Reference data)

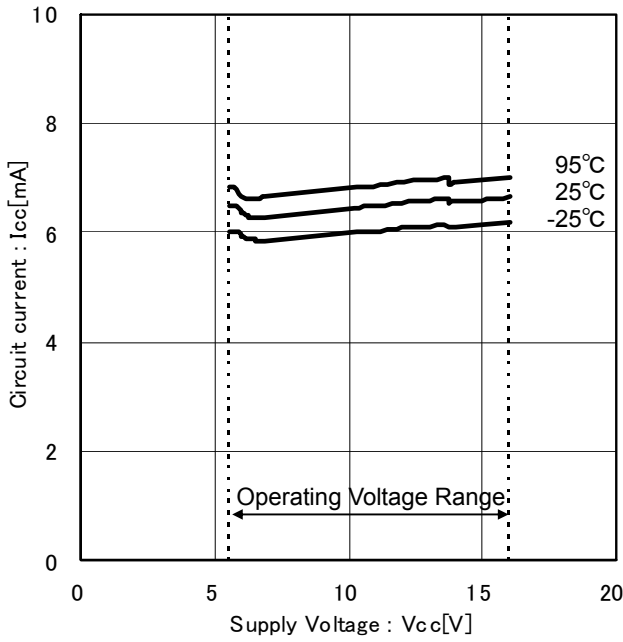

Fig.3 Circuit current

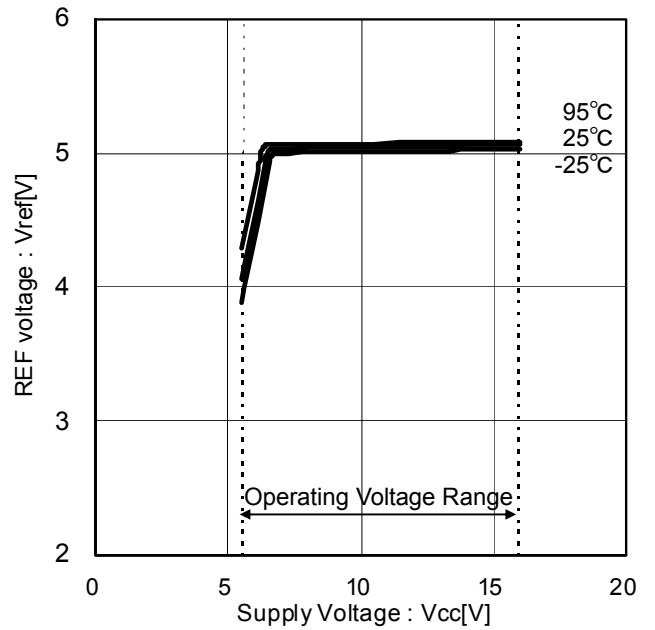

Fig.4 Reference voltage

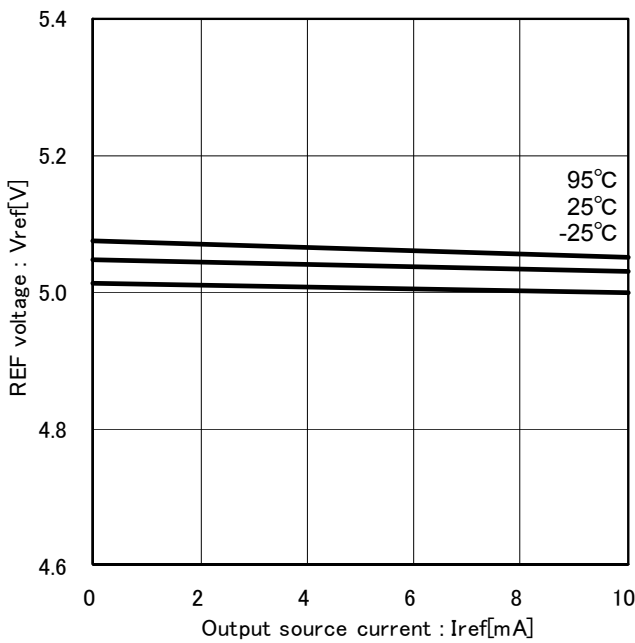

Fig.5 Reference voltage current ability (Vcc=12V)

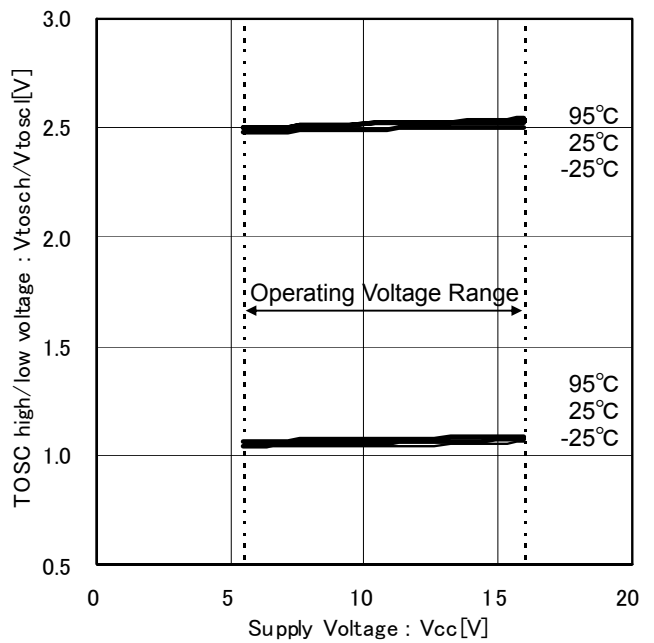

Fig.6 TOSC high/low voltage

● Typical Performance Curves (Reference data)

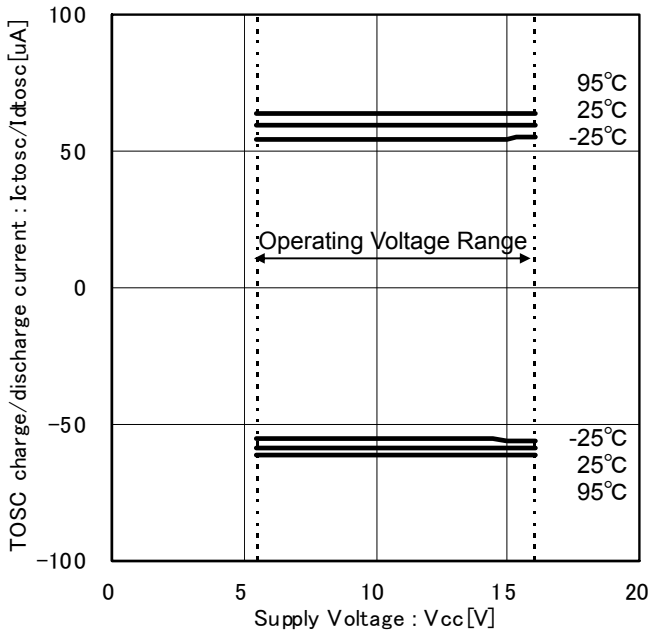

Fig.7 TOSC Charge/Discharge current

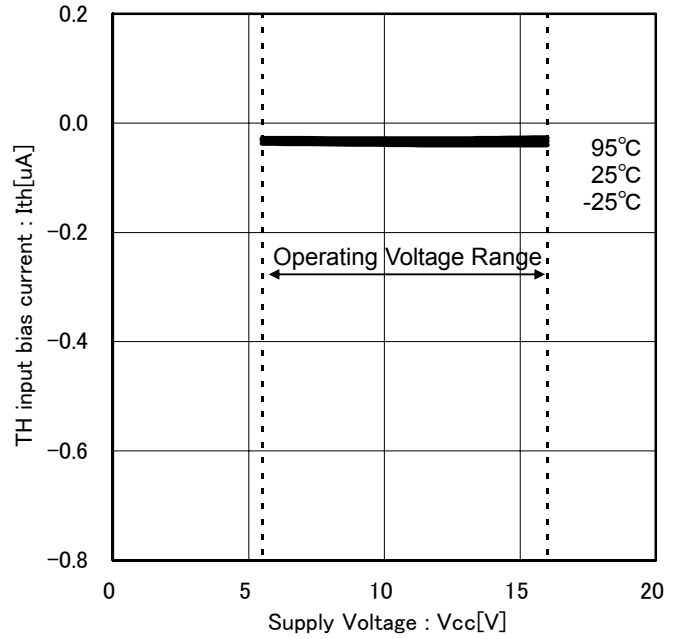

Fig.8 TH input bias current

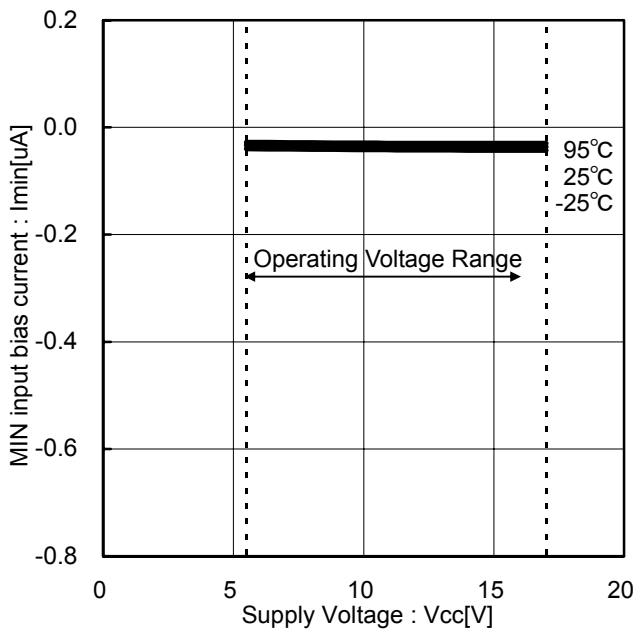

Fig.9 MIN input bias current

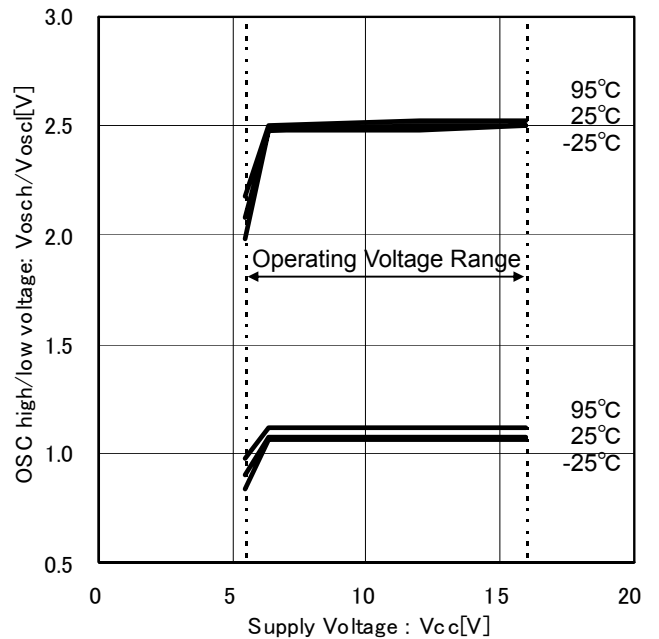

Fig.10 OSC high/low voltage

● Typical Performance Curves (Reference data)

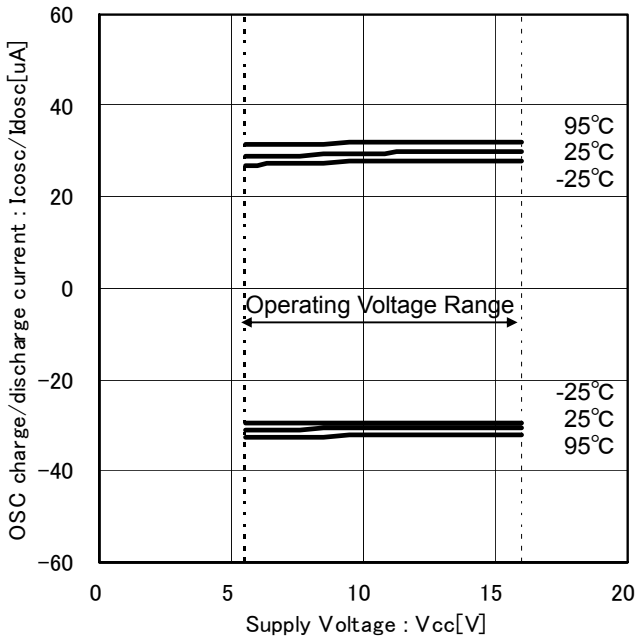

Fig.11 OSC charge/Discharge current

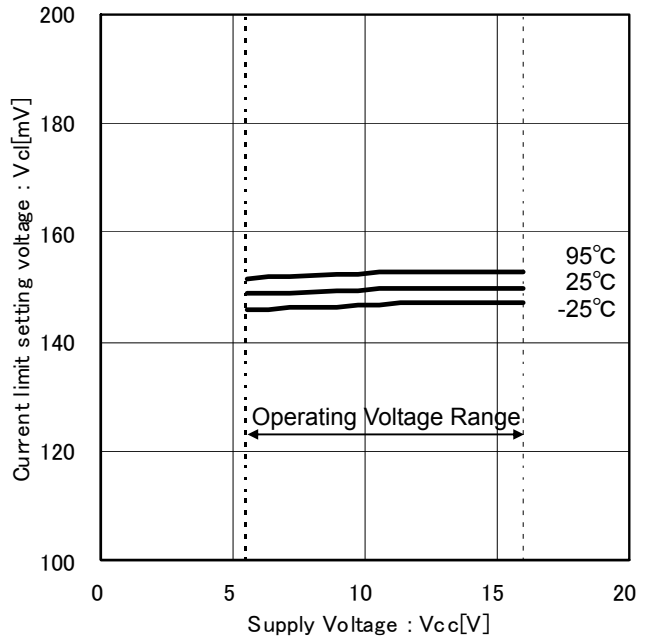

Fig.12 Current limit voltage

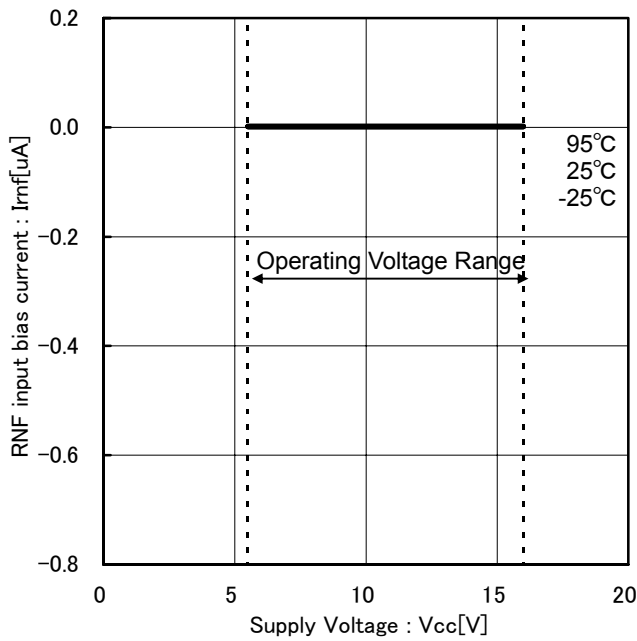

Fig.13 RNF input bias current

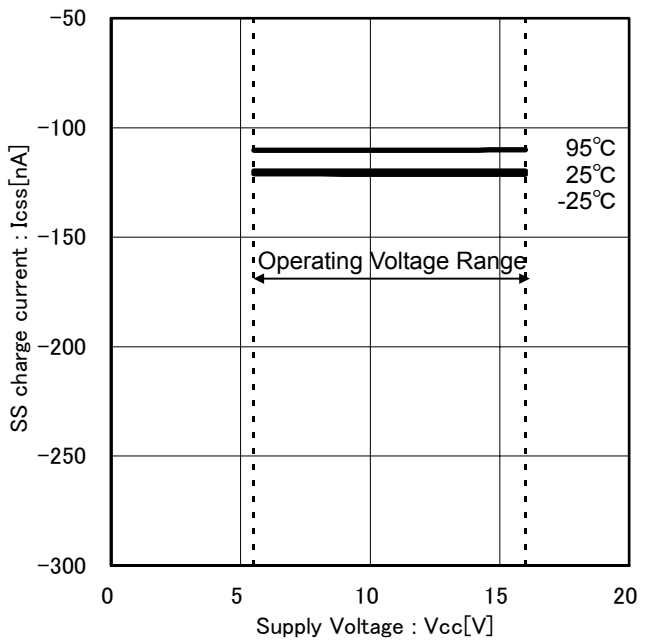

Fig.14 SS Charge current

● Typical Performance Curves (Reference data)

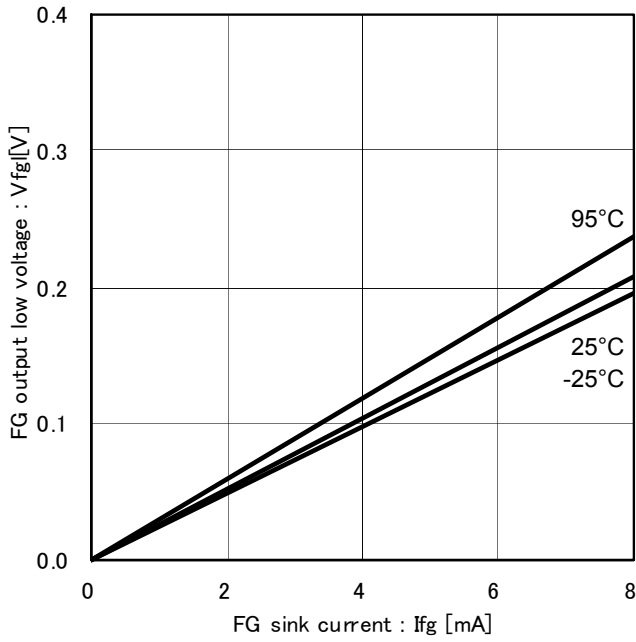

Fig.15 FG low voltage (Vcc=12V)

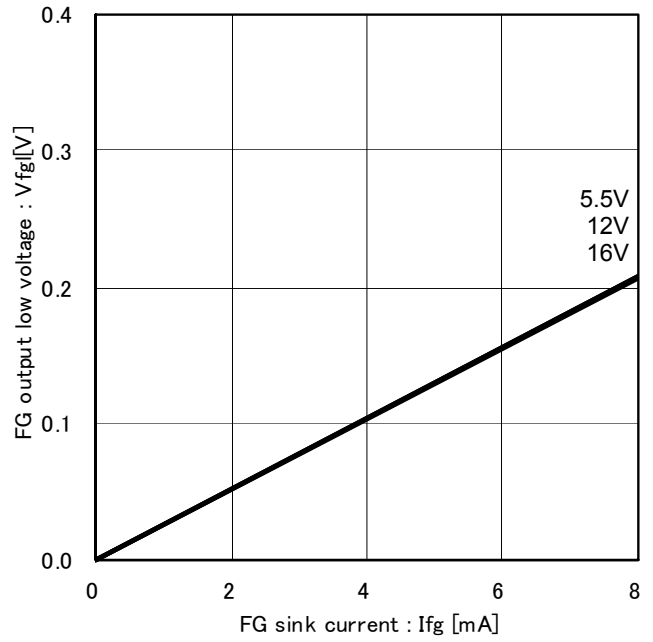

Fig.16 FG low voltage (Ta=25°C)

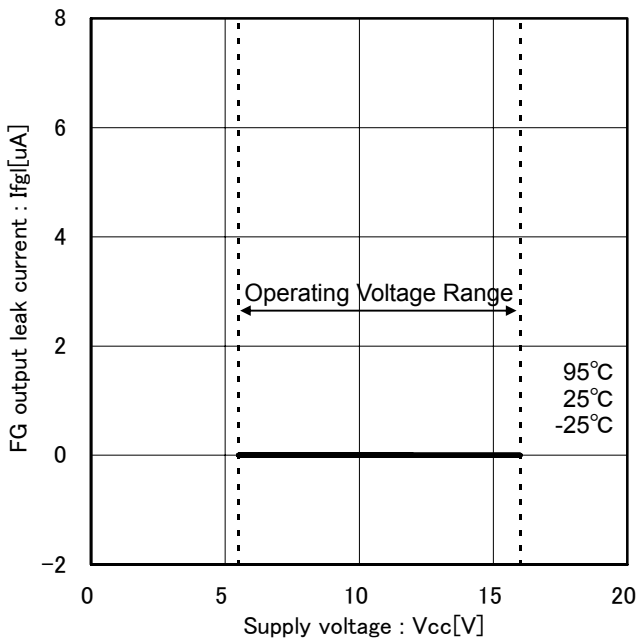

Fig.17 FG output current

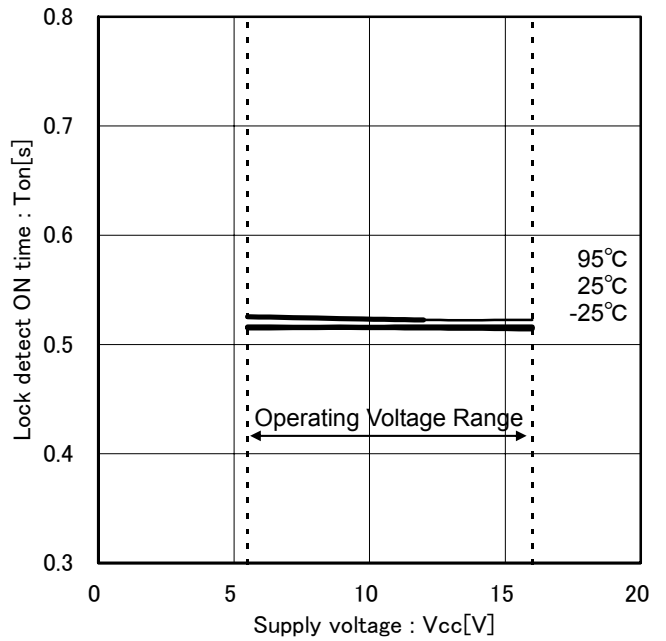

Fig.18 Lock detect ON time

● Typical Performance Curves (Reference data)

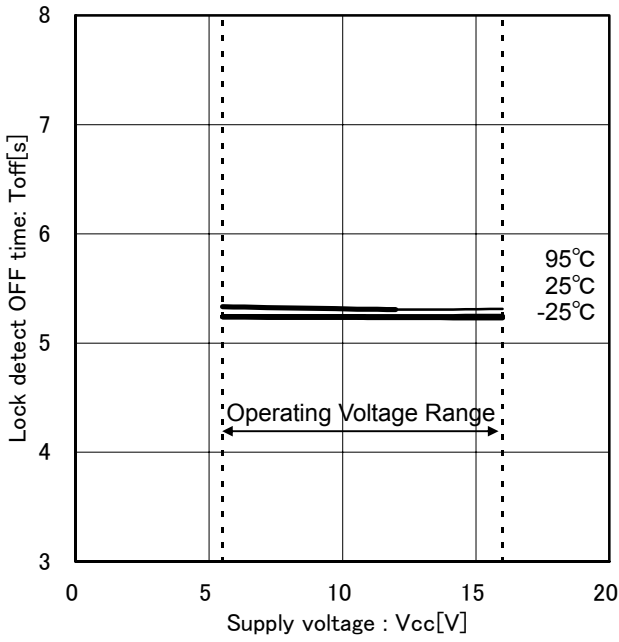

Fig.19 Lock detect OFF time

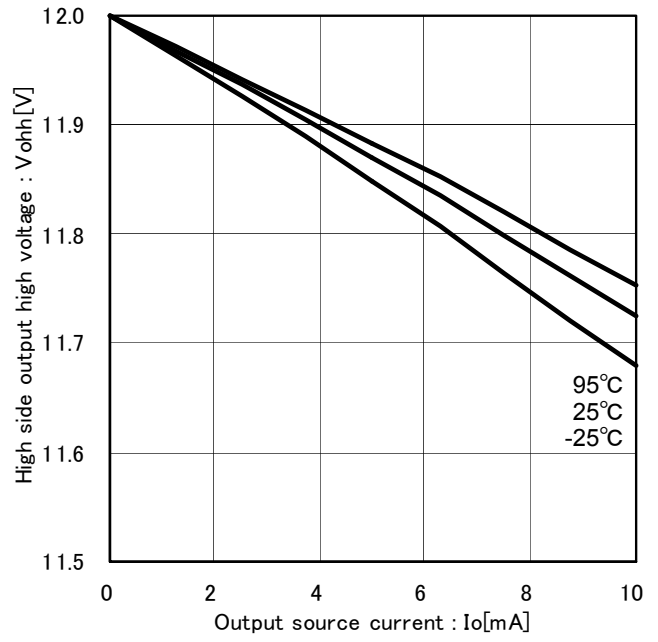

Fig.20 Hi side Output Hi voltage (V_{cc}=12V)

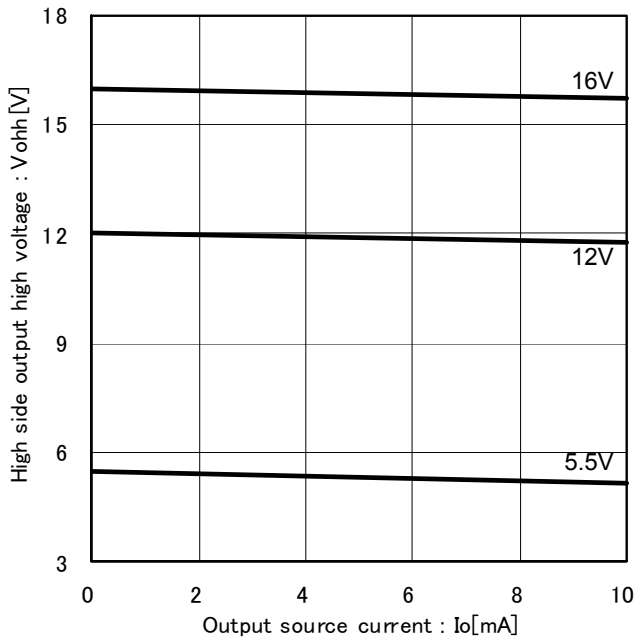

Fig.21 Hi side Output Hi voltage (T_a=25°C)

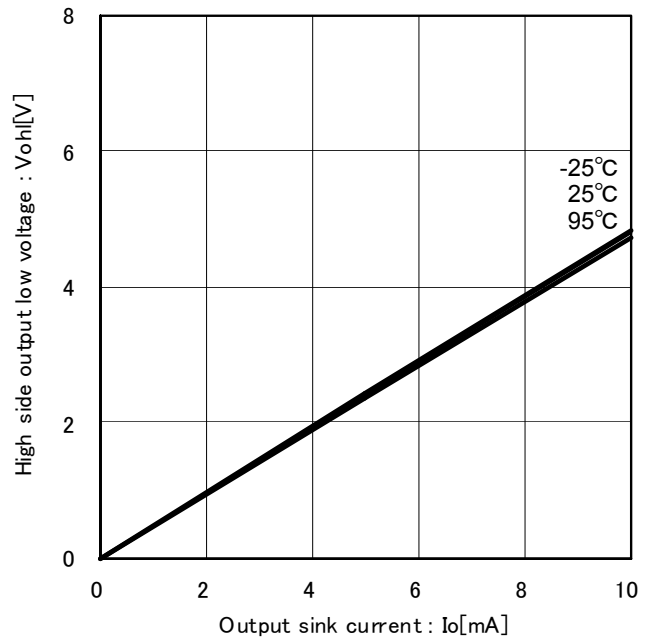

Fig.22 Hi side Output Lo voltage (V_{cc}=12V)

● Typical Performance Curves (Reference data)

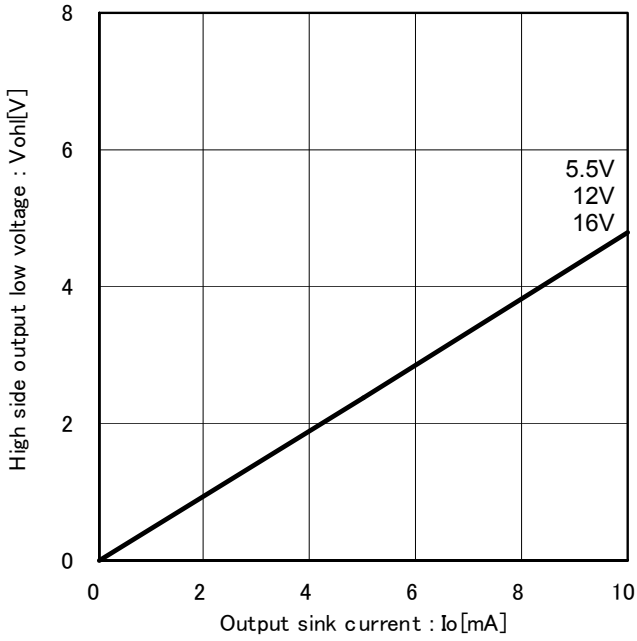

Fig.23 Hi side Output Lo voltage (Ta=25°C)

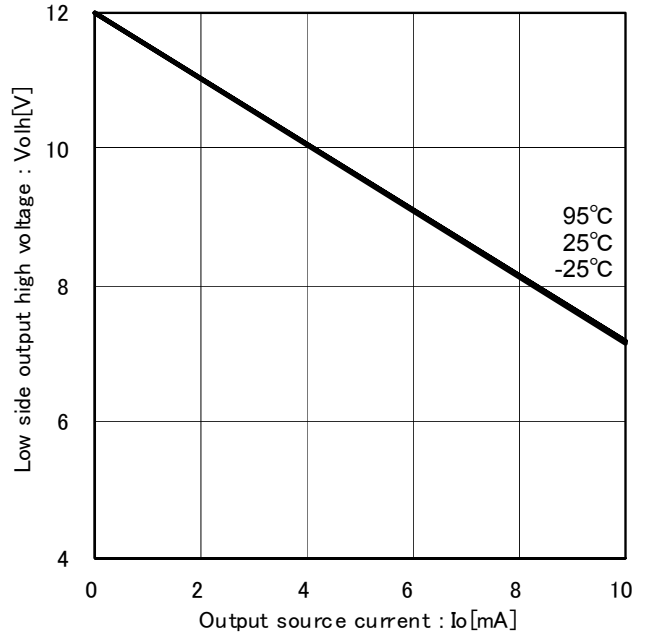

Fig.24 Lo side Output Hi voltage (Vcc=12V)

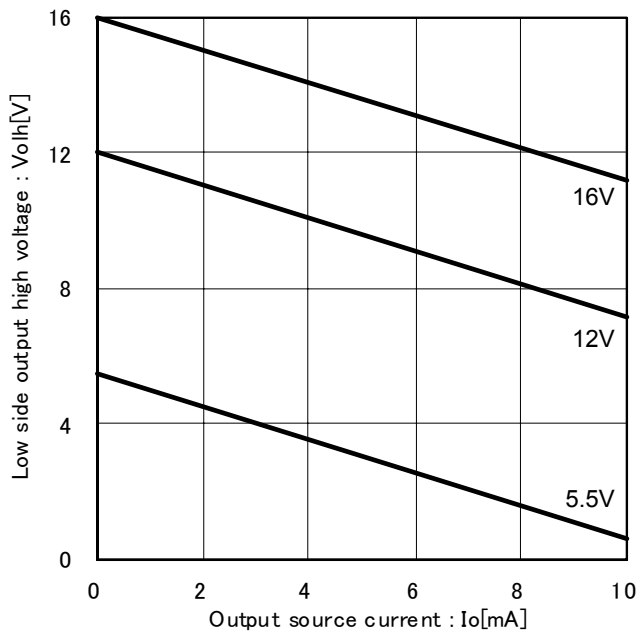

Fig.25 Lo side Output Lo voltage (Ta=25°C)

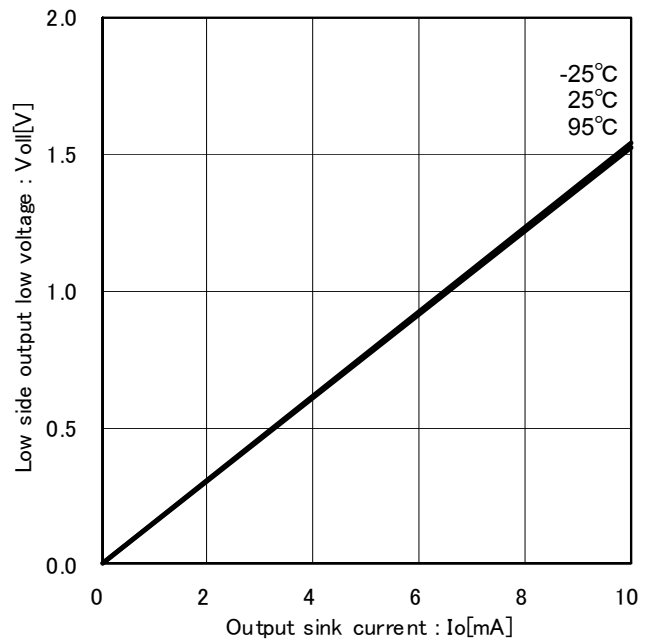

Fig.26 Lo side Output Lo voltage (Vcc=12V)

● Typical Performance Curves (Reference data)

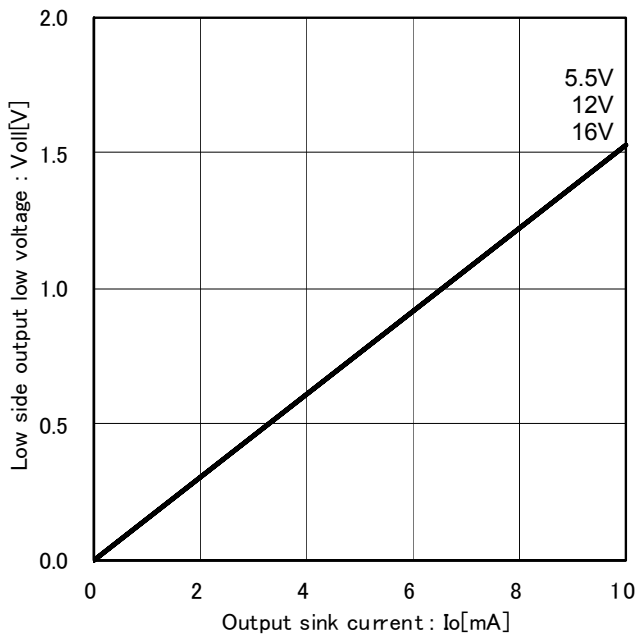

Fig.27 Lo side Output Lo voltage (Ta=25°C)

● Application Circuit example (constant values are for reference)

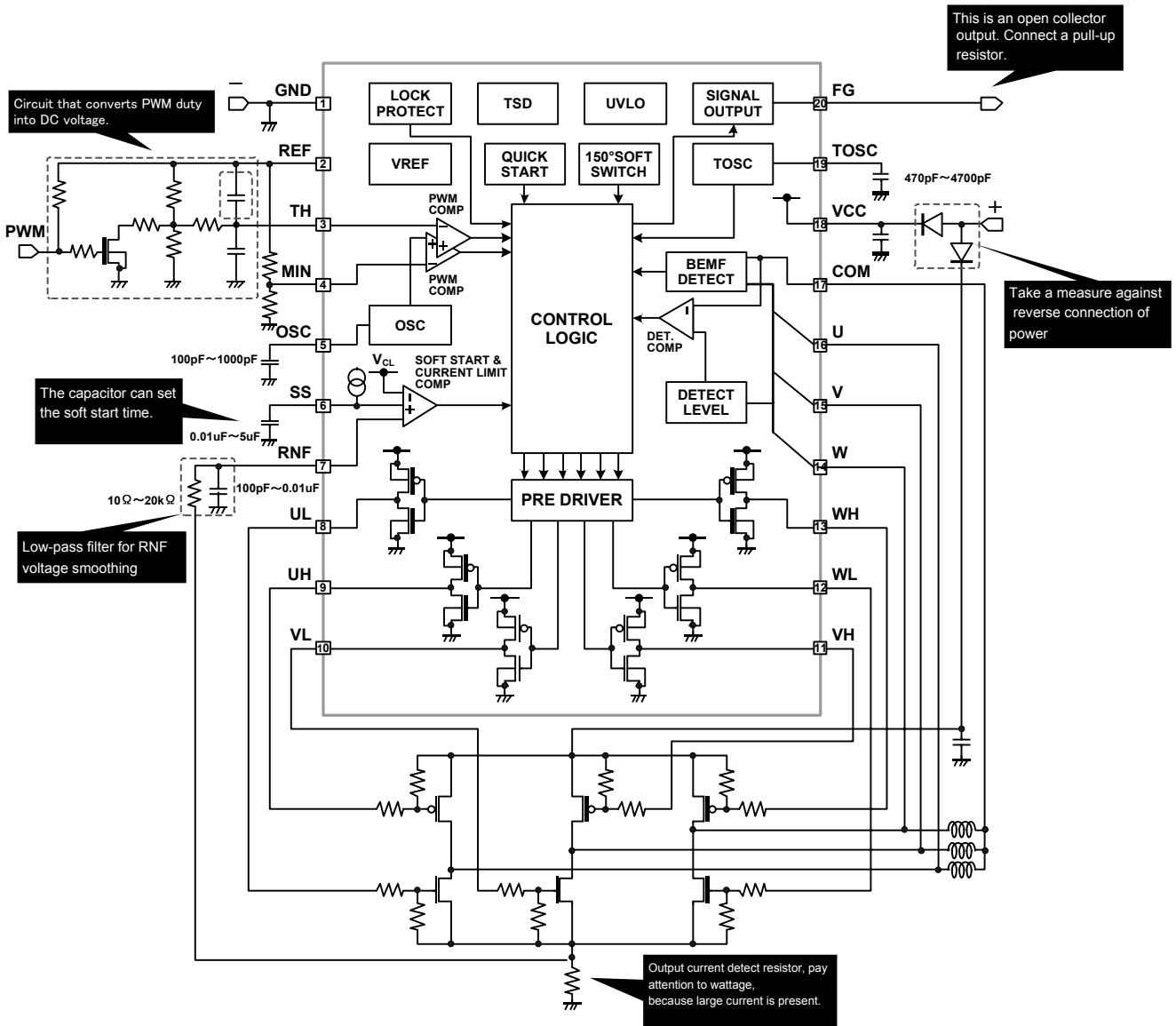

Fig.26 Application of converting PWM duty to DC voltage

Board Design note

- Motor power, outputs, and ground lines are made as wide as possible.
- IC power and ground lines are made as wide as possible.
- IC ground (signal ground) line is common with the application ground except motor ground, and placed near to (-) land.
- Bypass capacitors (Vcc side and Vm side) are placed near Vcc terminal and FETs respectively.

● Functional descriptions

1) Sensorless Drive

BD63441AFU is a motor driver IC for three-phase brushless DC motor without a hall sensor.

Synchronized start-up mechanism and Back Electromotive Force (BEMF) detection driving

BD63441AFU's start-up is a synchronized start-up mechanism. When BEMF signal isn't detected for a certain period of time upon start-up, synchronized start-up mechanism output logic forcibly by using standard synchronized signal (sync signal) and drive the motor forward. This motor starting mechanism is called synchronized start-up and the period of a sync signal is called synchronized period.

After the synchronous starting section is completed, BEMF detect drive follows. In BEMF detection drive, the induction voltage of each phase is detected which occurs due to the rotation of motor, and the logic for forward rotation is outputted. A simple timing diagram (outline) is shown in Fig.27. FG signal is fixed to High for about 0.6s at motor start-up.

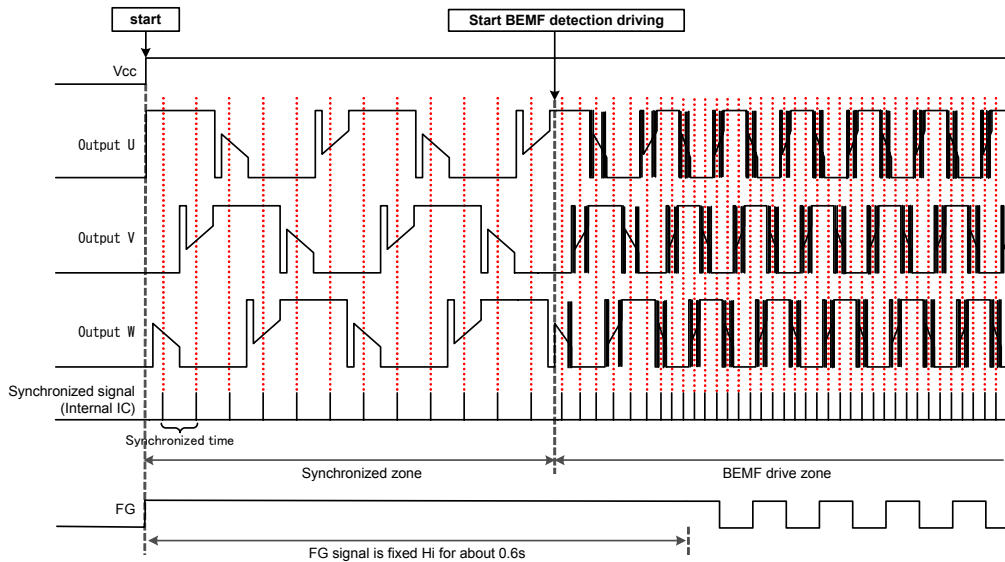

Fig.27 Synchronized start-up and BEMF detection driving timing diagram (outline)

Synchronized reference period (Ttosc) and synchronized period (Tosc)

Synchronized reference period is set by the capacitor value (Ctosc) connected to TOSC terminal. When the capacitor value is small, synchronized reference period becomes short. Proper value selection of external capacitor is important. Synchronized reference period and the IC internal constant determine synchronous period (Tosc). Synchronized reference period is set by the capacitor value (Ctosc) connected to TOSC terminal.

$$T_{tosc}[s] = \{C_{tosc}[F] \times (|I_{dtosc}[A]| + |I_{ctosc}[A]|) \times (V_{tosch}[V] - V_{toscl}[V])\} / \{|I_{dtosc}[A]| \times I_{ctosc}[A]|\}$$

$$T_{osc} [s] = 2000 \times T_{tosc}[s]$$

(ex.) When Ctosc = 2200pF, the synchronized reference period is around 106µs and the synchronous period is 212 ms.

$$T_{tosc}[s] = \{2200[pF] \times \{|60[\mu A]| + |-60[\mu A]|\} \times (2.5[V] - 1.05[V])\} / \{|60[\mu A]| \times (-60[\mu A])|\}$$

$$= 106 \times 10^{-6}[s]$$

$$T_{osc}[s] = 2000 \times 106[\mu s]$$

$$= 212 \times 10^{-3}[s]$$

TOSC capacitor - synchronized period conversion table

TOSC capacitor (Ctosc) [pF]	Synchronized period (Tosc) [ms]
470	46
680	66
1000	96
2200	212
3300	320
4700	454

(Reference value)

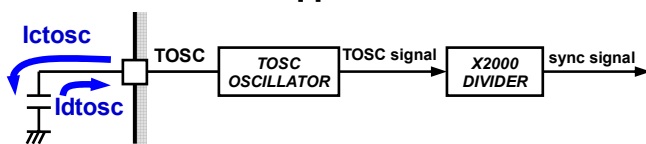

Fig.28 TOSC capacitor and IC internal circuit

Setting the capacitor value for TOSC

The appropriate duration of synchronized period is differing with characteristic and parameter of motor. Appropriate capacitance is decided by confirming the start-up with various capacitor values. First, confirm start-up with 2200pF, next with 2400pF, 2700pF... , 2000pF, 1800pF... etc. Right capacitor value is decided after confirming the maximum NG start-up value and minimum NG start-up value. For large load motor, the capacitor value tends to become large. In determining the capacitor value, consider the motor characteristics. Also, test the start-up of the motor and give sufficient margin to capacitor value.

●Functional descriptions

1) Sensorless Drive -continued

PWM soft switching

A PWM soft switching function changes the current between phases smoothly by running PWM operation. This function reduces noise and vibration of the motor.

In Figure 29 the timing diagram of the output signals from the U, V, W phases as well as the FG terminal is shown.

Assuming that a three-slot motor is used, two pulse outputs of FG are produced for one motor cycle. The three phases are excited in the order of U, V and W.

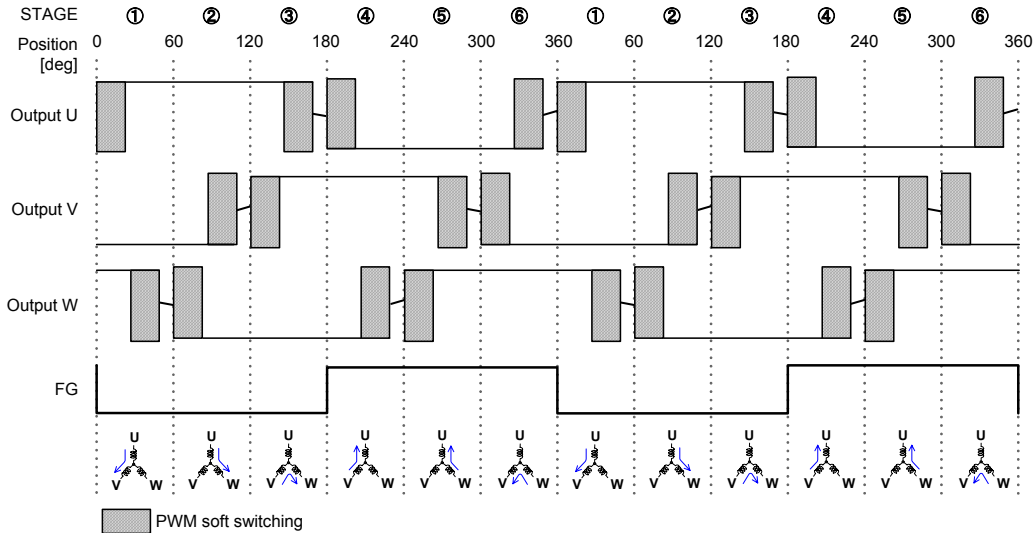

Fig.29 BEMF detection drive and PWM soft switching timing diagram

Stage	Motor output logic		
	Output U	Output V	Output W
①	H	L	Hi-Z
②	H	Hi-Z	L
③	Hi-Z	H	L
④	L	H	Hi-Z
⑤	L	Hi-Z	H
⑥	Hi-Z	L	H

*Output pattern changes in the flow of "1→2→3 to 6→1"
H; High, L; Low, Hi-Z; High impedance

2) Lock protection and automatic recovery circuit

To prevent passing a current to the coil on any phase when the motor is locked, a function which can turn OFF the output for a certain period of time and then automatically restore itself to the normal operation is added. During the motor rotation, an appropriate logic based on the induced electromotive voltage is continuously given to each phase. On the other hand, when the motor is locked, no induced electromotive voltage is obtained. When the induced electromotive voltage is not detected for a predetermined time (TON) of 0.5s (typ), the motor is considered locked and the output is turned OFF for a period (TOFF) of 5.0s (typ). With this feature, the motor is protected against locking. Lock protection timing diagram is shown in Fig.30.

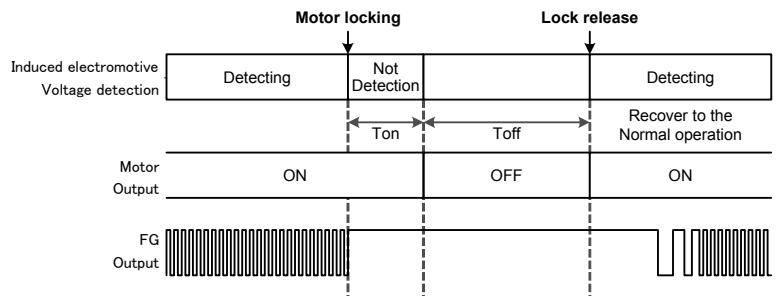

Fig.30 Lock protection (incorporated counter system) timing diagram

3) Under voltage lock out circuit (UVLO)

When operating under the guaranteed power supply voltage of 5.5V (typ), the transistor on the output is turned OFF at a supply voltage of 3.9V (typ). There's a hysteresis of 250mV and normal operation returns at 4.15V (typ). This function is built to prevent unpredictable operations, such as large amount of current passing through the output. By turning OFF the output during an operation at a very low power supply voltage, abnormal operation in the internal circuit is prevented. It's in OFF mode when UVLO is activated (upper and lower MOSFET are turned OFF).

● Functional descriptions

4) Variable speed operation

Rotational speed can be controlled by changing the PWM duty cycle on the output terminals, Upper side output (UH, VH, WH) and Lower side output (UL, VL, WL).

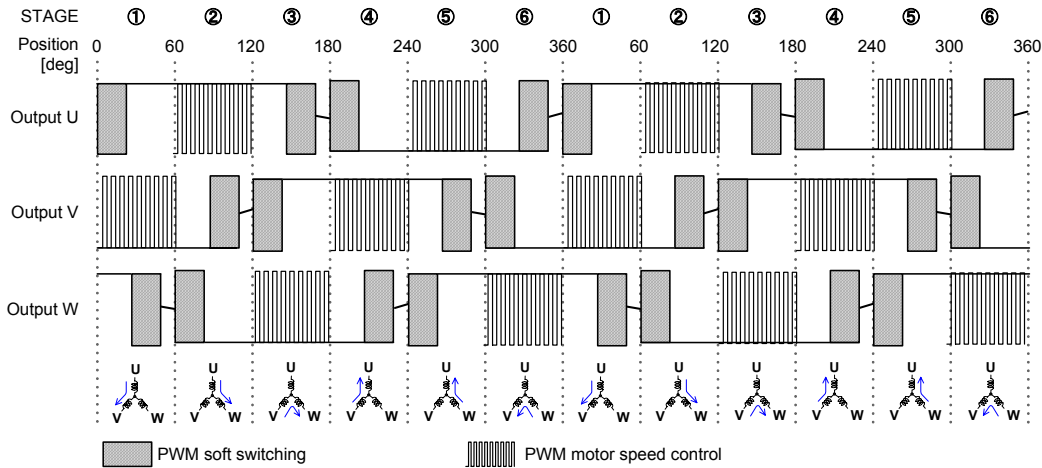

Fig.31 BEMF detection driving (PWM control) and PWM soft switching timing diagram

As shown in Fig.32, to change the output ON time, a DC input voltage from TH terminal is compared to the triangle wave produced by the OSC circuit. MIN terminal is use to set the minimum rotational speed. ON time is determined by either TH terminal voltage or MIN terminal voltage, whichever is lower. Moreover, to prevent the simultaneous turning ON and current flow between upper and lower side FET at PWM operation, a 600ns (typ) is set between output change.

OSC voltage > TH voltage (MIN voltage): PWM output is ON

OSC voltage < TH voltage (MIN voltage): PWM output is OFF

Resistor divider of the internal regulator (REF terminal equal to typ. 5.0V) generates OSC high and low voltage level of typically 2.5V and 1.05V respectively, and the ratio of those voltages is designed not to fluctuate easily. When the input voltage at TH terminal is constant, the effect of OSC H/L voltage fluctuation is large. However, an application can be made which is not easily affected by the fluctuation of the triangular wave by generating TH voltage from REF. For application that requires high precision, determine the value with sufficient margin after taking full consideration of external components.

The voltage of TH and MIN terminals are unstable when left open, therefore input voltage to both terminals when turning on the IC's power supply (Vcc).

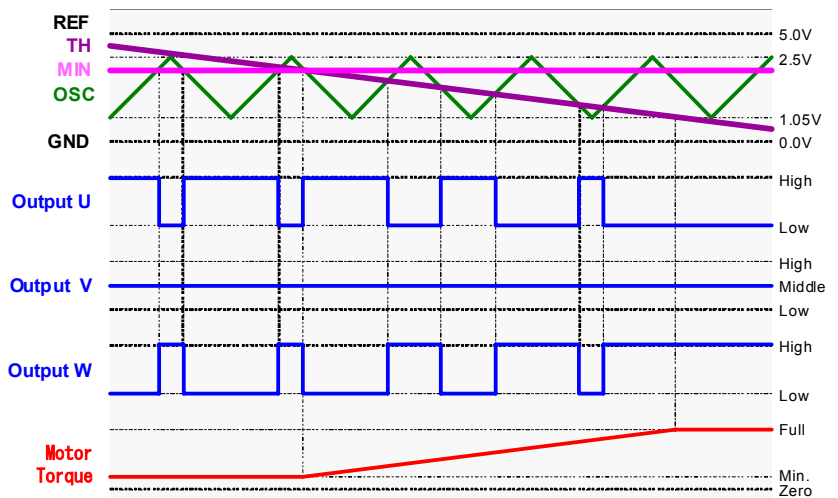
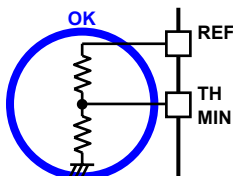
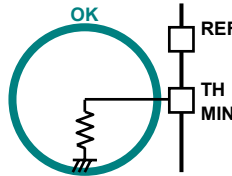

Fig.32 DC input operation timing chart (when (U, V, W) = (L, M, H))

Setting less than internal OSC High level (Torque ON setting)



Pull down setting (Torque ON setting)



Pull up setting (Torque OFF setting)

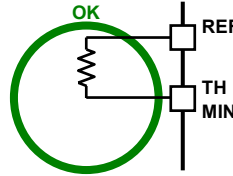

Open setting (Prohibit input)

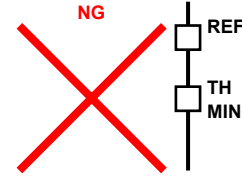

Fig.33 Setting of the variable speed function

Output frequency setting

The PWM Frequency (Fosc) in which the motor is operated is set according to the capacitor value (Cosc) connected to OSC terminal.

$$Fosc[Hz] = (|I_{dosc}[A] \times I_{cosc}[A]|) / \{Cosc[F] \times (|I_{dosc}[A]| + |I_{cosc}[A]|) \times (V_{osch}[V] - V_{osci}[V])\}$$

(ex.) When Cosc is 330pF, the PWM output frequency is 31kHz.

$$Fosc[Hz] = \{30[\mu A] \times (-30[\mu A])\} / \{330[pF] \times (30[\mu A] + |-30[\mu A]|) \times (2.5[V] - 1.05[V])\} = 31 \times 10^3[Hz]$$

●Functional descriptions

5) Current limit

The current limit circuit turns off the output when a certain amount of the current flowing to the motor coil is exceeded. The amount of current needed to operate the circuit is determined by adjusting the internal setting voltage and voltage of RNF terminal. In Fig.34, I_o is the current flowing to the motor coil, and $R1$ is the resistance that detects current, and P_R is the power consumption of $R1$. When $R1=0.1\Omega$, the current limit setting voltage (V_{CL}) is 150mV (typ.),

$$\begin{aligned} I_o[A] &= V_{cl}[V] / R1[\Omega] & P_R[W] &= V_{cl}[V] \times I_o[A] \\ &= 150[mV] / 0.1[\Omega] & &= 150[mV] \times 1.5[A] \\ &= 1.5[A] & &= 0.225[W] \end{aligned}$$

Current limit circuit operates at 1.5A. When the current limit function is not used, RNF terminal should be shorted to GND. $R2$ and $C1$ consist of the low-pass filter for smoothing RNF voltage.

Share and assume the ground of $C1$ to be the small signal ground line with the GND pin of IC for the malfunction prevention of a current limit. Separate with the motor large current ground line with which RNF is connected. Soft start capacitor $C2$ described later is similar. (Refer to P.10 Board Design note c)

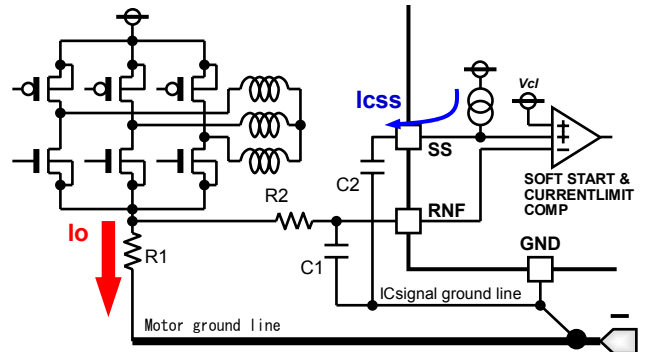

Fig.34 Current limit and ground line setting

6) Soft start

The function of soft start is to gradually increase the rotational speed of the motor in order to control the inrush current upon turning on the power supply, the quick start, and the motor restart of lock detection ON timing etc. The soft start time and the inclination are set by the charge of the capacitor connected to SS terminal. If the soft start function is not going to be used, open the SS terminal.

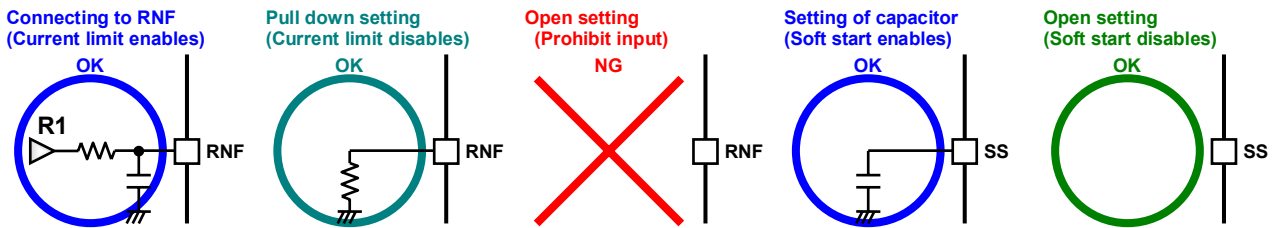

Fig.35 Setting of the current limit function and soft start function

If motor output current (I_{cut}) and time (T_{SS}) which is the reduction in Fig.36 are decided, the value of capacitor C_{SS} that sets a soft start can be calculated by the following expressions given that SS charge current (I_{SS}) is typ. 120nA.

$$\begin{aligned} T_{SS}[s] &= (C2[F] \times I_{cut}[A] \times R1[\Omega]) / I_{SS}[A] \\ (\text{ex.}) \text{ Assuming that } C2 &= 0.47[\mu F], I_{cut} = 1.2[A], \text{ and } R1 = 0.1[\Omega] \text{ then,} \\ T_{SS}[s] &= (0.47[\mu F] \times 1.2[A] \times 0.1[\Omega]) / 120[nA] \\ &= 0.47[s] \end{aligned}$$

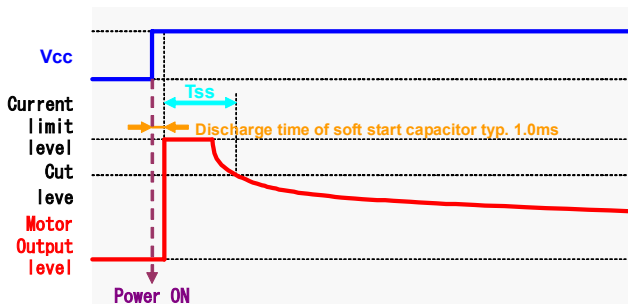

Fig.36 Output current characteristics without soft start

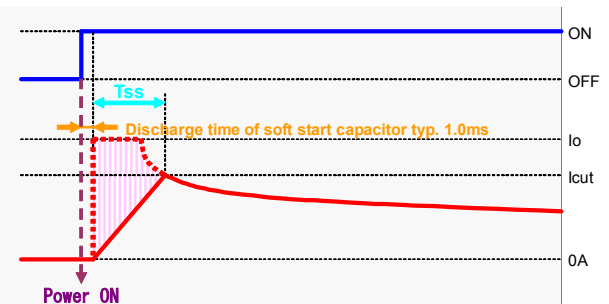

Fig.37 Output current characteristics with soft start

7) Quick start

When torque off logic is inputted by the control signal over fixed time ($80\mu s$), the lock protection function becomes off. And the motor could restart quickly at the timing of control signal in input.

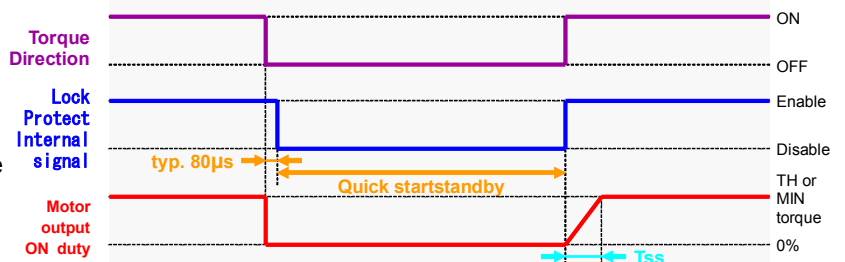

Fig.38 Torque direction and quick start timing chart

● Safety measure

1) Reverse connection protection diode

Reverse connection of power, results in IC destruction as shown in Fig.39. When reverse connection is possible, a diode must be added between power supply and Vcc in order to protect the IC from destruction.

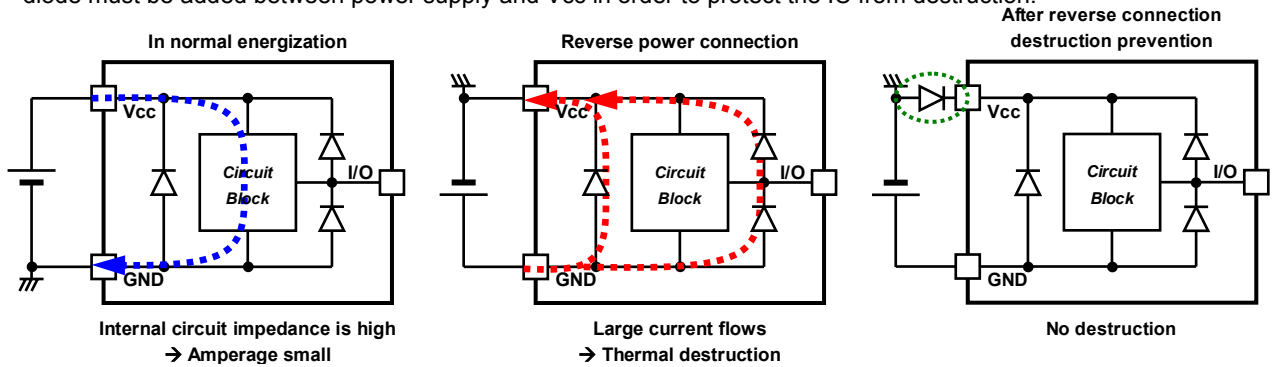

Fig.39 Flow of Current when power is reverse connected

2) Measure against Vcc voltage rise by back electromotive force

Back electromotive force (Back EMF) creates regenerative current to power supply. However, when reverse connection protection diode is connected, Vcc voltage rises due to diode that prevents current flow to power supply.

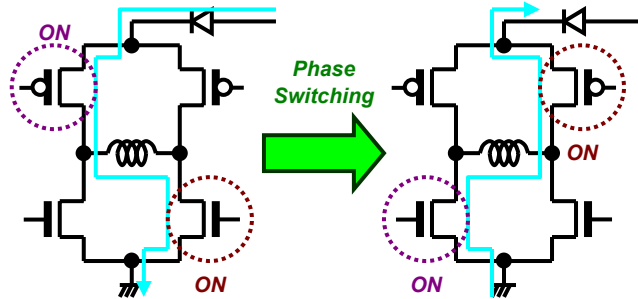

Fig.40 Vcc voltage rise by back electromotive force

In case where the maximum absolute rating of voltage is exceeded due to voltage rise by back electromotive force, place (A) Capacitor or (B) Zener diode between Vcc and GND. If necessary, add both (C).

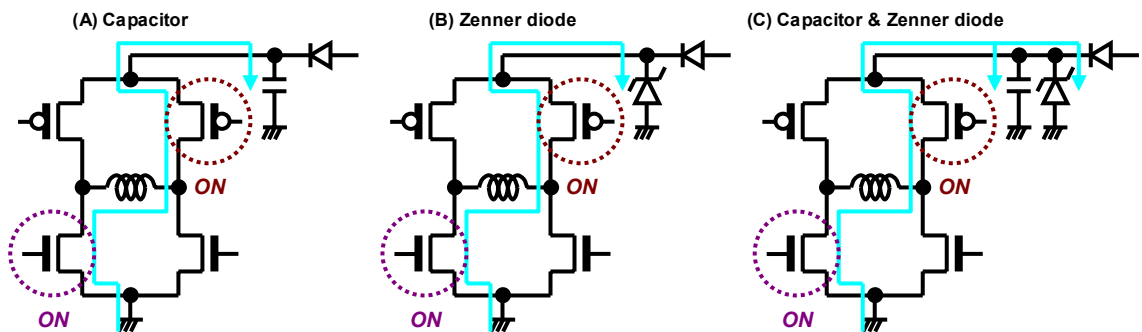

Fig.41 Measure against Vcc voltage rise

3) Problem of GND line PWM switching

Do not perform PWM switching of GND line because GND terminal potential cannot be kept to a minimum.

4) Protection of Rotational Speed Pulse (FG) open-drain output

FG output is an open drain and requires pull-up resistor. Adding resistor can protect the IC. An excess of absolute maximum rating, when FG terminal is directly connected to power supply, could damage the IC.

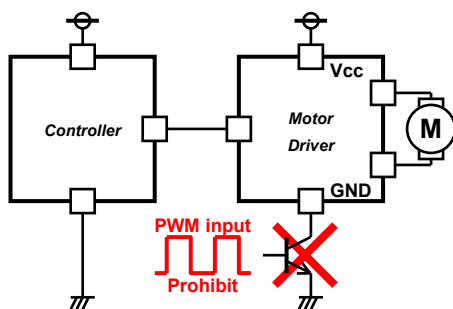

Fig.42 GND line PWM switching prohibited

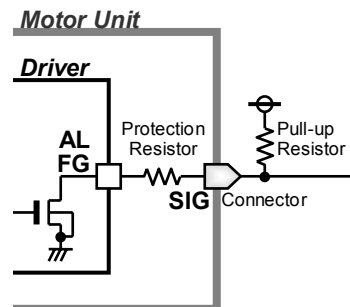

Fig.43 Protection of FG terminal

●Power dissipation

Power dissipation (total loss) indicates the power that can be consumed by IC at Ta=25°C (normal temperature). IC is usually heated when it consumes power, and the temperature of IC chip becomes higher than ambient temperature. The temperature that can be accepted by IC chip depends on circuit design, manufacturing process, etc., and therefore limit the power that can be consumed. Power dissipation is determined by the temperature allowed in IC chip (maximum junction temperature) and thermal resistance of package (heat dissipation capability). In general, the maximum junction temperature is equal to the maximum value in the storage temperature range.

Heat generated by consumed power of IC is radiated from the mold resin or lead frame of package. The parameter which indicates this heat dissipation capability (resist the release of heat) is called heat resistance, represented by the symbol θ_{ja} [°C/W]. This heat resistance can estimate the temperature of IC inside the package. Fig.44 shows the model of heat resistance of the package. Heat resistance θ_{ja} , ambient temperature Ta, junction temperature Tj, and power consumption P can be calculated by the equation below:

$$\theta_{ja} = (T_j - T_a) / P \text{ [°C/W]}$$

Thermal de-rating curve indicates that power can be consumed by IC with reference to ambient temperature. Power that can be consumed by IC begins to attenuate at certain ambient temperature. This gradient is determined by thermal resistance θ_{ja} . Thermal resistance θ_{ja} depends on chip size, power consumption, package ambient temperature, packaging condition, wind velocity, etc., even when the same package is used. Thermal de-rating curve indicates a reference value measured at a specified condition. Fig.45 shows a thermal de-rating curve (Value when mounting FR4 glass epoxy board 70[mm] x 70[mm] x 1.6[mm] (copper foil area below 3[%])). Thermal resistance θ_{jc} from IC chip joint part to the package surface part of mounting the above-mentioned, same substrate is shown in the following as a reference value.

$$\theta_{jc} = 36 \text{ [°C/W]} \text{ (reference value)}$$

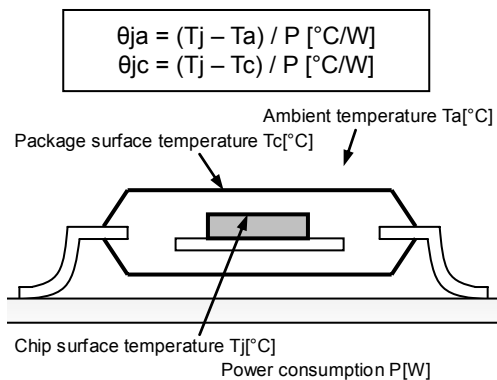

Fig.44 Thermal resistance

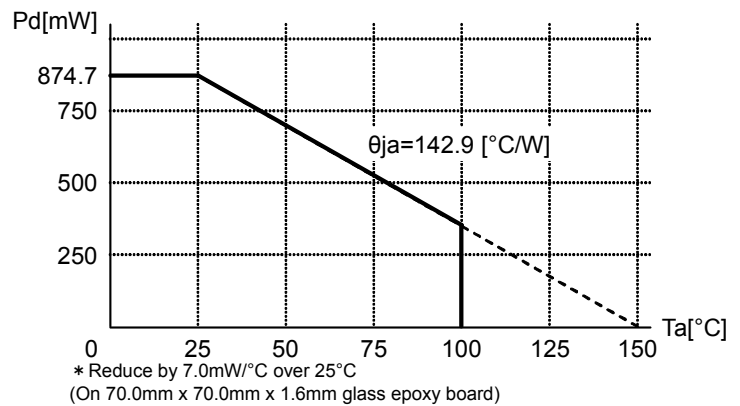
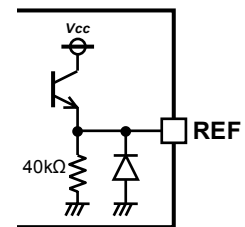
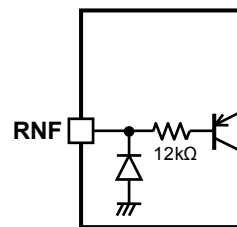
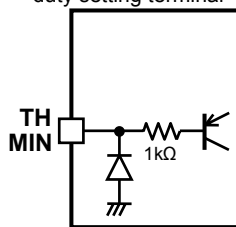
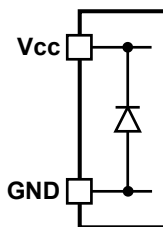

Fig.45 Thermal de-rating curve

●I/O equivalence circuit(Resistance values are typical)

- 1) Power supply terminal, and Ground terminal
- 2) Output duty controllable input terminal and Minimum output duty setting terminal
- 3) Output current detection terminal
- 4) Reference voltage output terminal



- 5) Oscillating capacitor connecting terminal

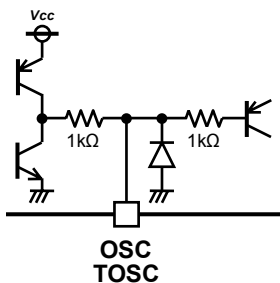

- 6) Soft start capacitor connecting terminal

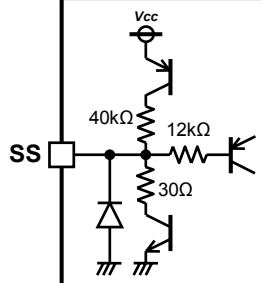

- 7) Motor output terminal (Upper side output)

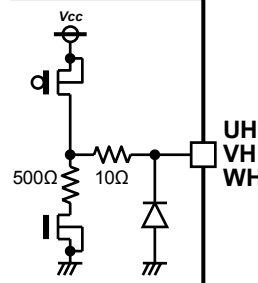

- 8) Motor output terminal (Lower side output)

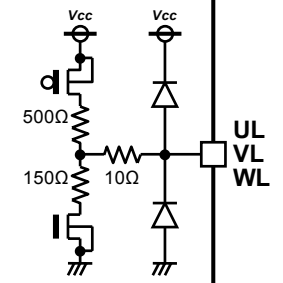

- 9) Coil midpoint terminal

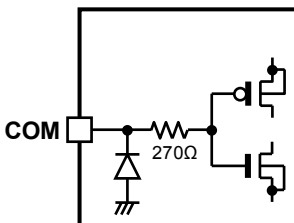

- 10) Motor output detection terminal

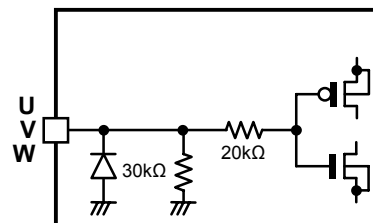

- 11) FG output terminal

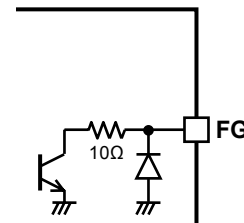

●Operational Notes

- 1) Absolute maximum ratings
Operating the IC over the absolute maximum ratings may damage the IC. In addition, it is impossible to predict all destructive situations such as short-circuit modes, open circuit modes, etc. Therefore, it is important to consider circuit protection measures, like adding a fuse, in case the IC is operated in a special mode exceeding the absolute maximum ratings.
- 2) Reverse connection of power supply
Connecting the power supply in reverse polarity can damage the IC. Take precautions against reverse polarity when connecting the power supply, such as mounting an external diode between the power supply and the IC's power supply terminals.
- 3) Power supply lines
Back EMF due to the output coil may result to a return current into the IC. Caution should be taken by putting capacitor between power supply and GND as a pathway for the return current. Consider the effect of temperature and aging on the capacitance value when using electrolytic capacitors
- 4) GND potential
It is possible that the potential at the motor output terminal may deflect below GND terminal due to the effect of back electromotive force of motor. The potential of GND terminal must be the lowest potential at all operating conditions, except the motor outputs terminals which may deflect below GND level due to the effect of back electromotive force of the motor coil. Also ensure that all terminals except GND and motor output terminals do not fall below GND voltage including transient response. Malfunction may occur depending on the condition, environment, and characteristics of individual motor. Please make sure there is no problem found operating the IC.
- 5) Thermal consideration
Use a thermal design that allows for a sufficient margin by taking into account the permissible power dissipation (Pd) in actual operating conditions.
- 6) Short between pins and mounting errors
Be careful when mounting the IC on printed circuit boards. The IC may be damaged if it is mounted in a wrong orientation or if pins are shorted together.
- 7) Operation under strong electromagnetic field
Operating the IC in the presence of a strong electromagnetic field may cause the IC to malfunction.
- 8) ASO
When using the IC, set the output transistor so that it does not exceed absolute maximum ratings or ASO.
- 9) Thermal shutdown circuit (TSD)
The IC has a built-in thermal shutdown circuit (TSD circuit). TSD operating temperature is 175°C (typ) and has a hysteresis width of 25°C (typ). When the chip temperature rises and TSD circuit works, the output becomes open state. TSD circuit is designed only to shut the IC off to prevent thermal runaway. It is not designed to protect the IC from damage or guarantee its operation. Do not continue to operate the IC after this function is activated. Do not use the IC in conditions where this function will always be activated.
- 10) Testing on application boards
When testing the IC on an application board, connecting a capacitor directly to a low-impedance output pin may subject the IC to stress. Always discharge capacitors completely after each process or step. The IC's power supply should always be turned off completely before connecting or removing it from the test setup during the inspection process. To prevent damage from static discharge, ground the IC during assembly and use similar precautions during transport and storage.
- 11) GND wiring pattern
When using both small-signal and large-current GND traces, the two ground traces should be routed separately but connected to a single ground at the reference point of the application board to avoid fluctuations in the small-signal ground caused by large currents. Also ensure that the GND traces of external components do not cause variations on the GND voltage.
- 12) Capacitor between output and GND
If a large capacitor is connected between the output pin and GND pin, current from the charged capacitor can flow into the output pin and may destroy the IC when the VCC or VIN pin is shorted to ground or pulled down to 0V. Use a capacitor smaller than 100uF between output and GND.
- 13) Input Terminals
In the construction of this IC, P-N junctions are inevitably formed creating parasitic diodes or transistors. The operation of these parasitic elements can result in mutual interference among circuits, operational faults, or physical damage. Therefore, conditions which cause these parasitic elements to operate, such as applying a voltage to an input pin lower than the GND voltage should be avoided. Furthermore, do not apply a voltage to the input terminals when no power supply voltage is applied to the IC. Even if the power supply voltage is applied, make sure that the input terminals have voltages within the values specified in the electrical characteristics of this IC.
- 14) In use
Although we can recommend the application circuits contained herein with a relatively high degree of confidence, we ask that you verify all characteristics and specifications of the circuit as well as its performance under actual conditions especially applications that requires high precision. In application where external components are changed, consider the external component and IC's static and transient characteristics in determining the values and give enough margins.

●Physical Dimension Tape and Reel Information

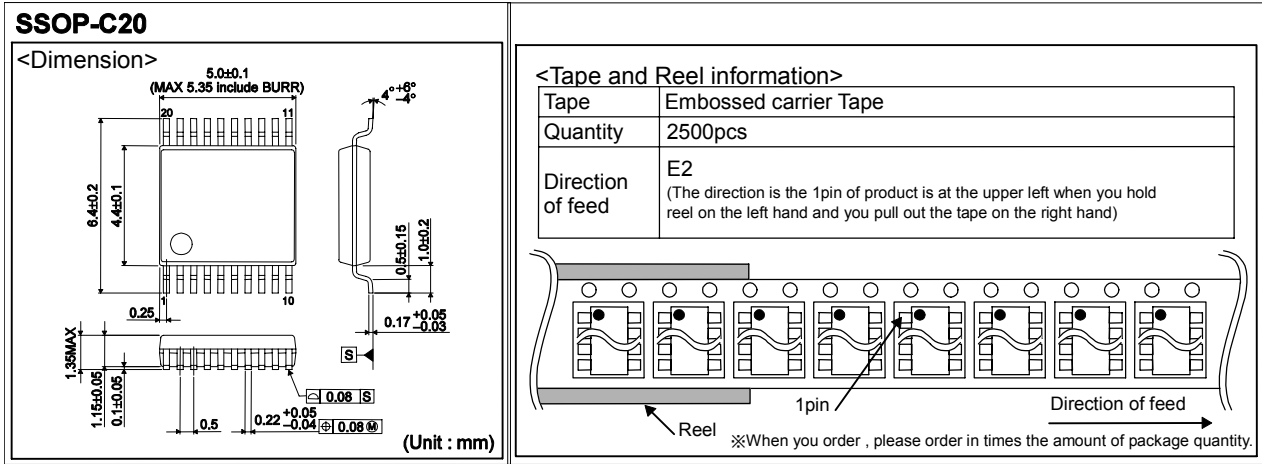

Marking Diagram

●Marking Diagram

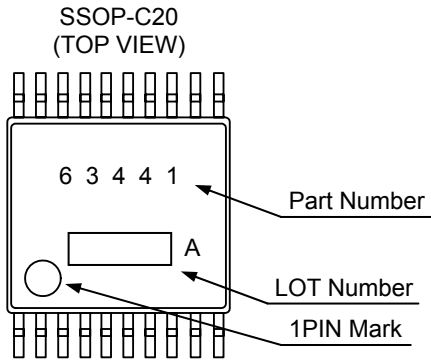

Notice

Precaution on using ROHM Products

- Our Products are designed and manufactured for application in ordinary electronic equipments (such as AV equipment, OA equipment, telecommunication equipment, home electronic appliances, amusement equipment, etc.). If you intend to use our Products in devices requiring extremely high reliability (such as medical equipment ^(Note 1), transport equipment, traffic equipment, aircraft/spacecraft, nuclear power controllers, fuel controllers, car equipment including car accessories, safety devices, etc.) and whose malfunction or failure may cause loss of human life, bodily injury or serious damage to property ("Specific Applications"), please consult with the ROHM sales representative in advance. Unless otherwise agreed in writing by ROHM in advance, ROHM shall not be in any way responsible or liable for any damages, expenses or losses incurred by you or third parties arising from the use of any ROHM's Products for Specific Applications.

(Note1) Medical Equipment Classification of the Specific Applications

JAPAN	USA	EU	CHINA
CLASS III	CLASS III	CLASS II b	CLASS III
CLASS IV		CLASS III	

- ROHM designs and manufactures its Products subject to strict quality control system. However, semiconductor products can fail or malfunction at a certain rate. Please be sure to implement, at your own responsibilities, adequate safety measures including but not limited to fail-safe design against the physical injury, damage to any property, which a failure or malfunction of our Products may cause. The following are examples of safety measures:
 - Installation of protection circuits or other protective devices to improve system safety
 - Installation of redundant circuits to reduce the impact of single or multiple circuit failure
- Our Products are designed and manufactured for use under standard conditions and not under any special or extraordinary environments or conditions, as exemplified below. Accordingly, ROHM shall not be in any way responsible or liable for any damages, expenses or losses arising from the use of any ROHM's Products under any special or extraordinary environments or conditions. If you intend to use our Products under any special or extraordinary environments or conditions (as exemplified below), your independent verification and confirmation of product performance, reliability, etc. prior to use, must be necessary:
 - Use of our Products in any types of liquid, including water, oils, chemicals, and organic solvents
 - Use of our Products outdoors or in places where the Products are exposed to direct sunlight or dust
 - Use of our Products in places where the Products are exposed to sea wind or corrosive gases, including Cl₂, H₂S, NH₃, SO₂, and NO₂
 - Use of our Products in places where the Products are exposed to static electricity or electromagnetic waves
 - Use of our Products in proximity to heat-producing components, plastic cords, or other flammable items
 - Sealing or coating our Products with resin or other coating materials
 - Use of our Products without cleaning residue of flux (even if you use no-clean type fluxes, cleaning residue of flux is recommended); or Washing our Products by using water or water-soluble cleaning agents for cleaning residue after soldering
 - Use of the Products in places subject to dew condensation
- The Products are not subject to radiation-proof design.
- Please verify and confirm characteristics of the final or mounted products in using the Products.
- In particular, if a transient load (a large amount of load applied in a short period of time, such as pulse. is applied, confirmation of performance characteristics after on-board mounting is strongly recommended. Avoid applying power exceeding normal rated power; exceeding the power rating under steady-state loading condition may negatively affect product performance and reliability.
- De-rate Power Dissipation (Pd) depending on Ambient temperature (Ta). When used in sealed area, confirm the actual ambient temperature.
- Confirm that operation temperature is within the specified range described in the product specification.
- ROHM shall not be in any way responsible or liable for failure induced under deviant condition from what is defined in this document.

Precaution for Mounting / Circuit board design

- When a highly active halogenous (chlorine, bromine, etc.) flux is used, the residue of flux may negatively affect product performance and reliability.
- In principle, the reflow soldering method must be used on a surface-mount products, the flow soldering method must be used on a through hole mount products. If the flow soldering method is preferred on a surface-mount products, please consult with the ROHM representative in advance.

For details, please refer to ROHM Mounting specification

Precautions Regarding Application Examples and External Circuits

1. If change is made to the constant of an external circuit, please allow a sufficient margin considering variations of the characteristics of the Products and external components, including transient characteristics, as well as static characteristics.
2. You agree that application notes, reference designs, and associated data and information contained in this document are presented only as guidance for Products use. Therefore, in case you use such information, you are solely responsible for it and you must exercise your own independent verification and judgment in the use of such information contained in this document. ROHM shall not be in any way responsible or liable for any damages, expenses or losses incurred by you or third parties arising from the use of such information.

Precaution for Electrostatic

This Product is electrostatic sensitive product, which may be damaged due to electrostatic discharge. Please take proper caution in your manufacturing process and storage so that voltage exceeding the Products maximum rating will not be applied to Products. Please take special care under dry condition (e.g. Grounding of human body / equipment / solder iron, isolation from charged objects, setting of Ionizer, friction prevention and temperature / humidity control).

Precaution for Storage / Transportation

1. Product performance and soldered connections may deteriorate if the Products are stored in the places where:
 - [a] the Products are exposed to sea winds or corrosive gases, including Cl₂, H₂S, NH₃, SO₂, and NO₂
 - [b] the temperature or humidity exceeds those recommended by ROHM
 - [c] the Products are exposed to direct sunshine or condensation
 - [d] the Products are exposed to high Electrostatic
2. Even under ROHM recommended storage condition, solderability of products out of recommended storage time period may be degraded. It is strongly recommended to confirm solderability before using Products of which storage time is exceeding the recommended storage time period.
3. Store / transport cartons in the correct direction, which is indicated on a carton with a symbol. Otherwise bent leads may occur due to excessive stress applied when dropping of a carton.
4. Use Products within the specified time after opening a humidity barrier bag. Baking is required before using Products of which storage time is exceeding the recommended storage time period.

Precaution for Product Label

QR code printed on ROHM Products label is for ROHM's internal use only.

Precaution for Disposition

When disposing Products please dispose them properly using an authorized industry waste company.

Precaution for Foreign Exchange and Foreign Trade act

Since our Products might fall under controlled goods prescribed by the applicable foreign exchange and foreign trade act, please consult with ROHM representative in case of export.

Precaution Regarding Intellectual Property Rights

1. All information and data including but not limited to application example contained in this document is for reference only. ROHM does not warrant that foregoing information or data will not infringe any intellectual property rights or any other rights of any third party regarding such information or data. ROHM shall not be in any way responsible or liable for infringement of any intellectual property rights or other damages arising from use of such information or data.:
2. No license, expressly or implied, is granted hereby under any intellectual property rights or other rights of ROHM or any third parties with respect to the information contained in this document.

Other Precaution

1. This document may not be reprinted or reproduced, in whole or in part, without prior written consent of ROHM.
2. The Products may not be disassembled, converted, modified, reproduced or otherwise changed without prior written consent of ROHM.
3. In no event shall you use in any way whatsoever the Products and the related technical information contained in the Products or this document for any military purposes, including but not limited to, the development of mass-destruction weapons.
4. The proper names of companies or products described in this document are trademarks or registered trademarks of ROHM, its affiliated companies or third parties.

General Precaution

1. Before you use our Products, you are requested to carefully read this document and fully understand its contents. ROHM shall not be in any way responsible or liable for failure, malfunction or accident arising from the use of any ROHM's Products against warning, caution or note contained in this document.
2. All information contained in this document is current as of the issuing date and subject to change without any prior notice. Before purchasing or using ROHM's Products, please confirm the latest information with a ROHM sales representative.
3. The information contained in this document is provided on an "as is" basis and ROHM does not warrant that all information contained in this document is accurate and/or error-free. ROHM shall not be in any way responsible or liable for any damages, expenses or losses incurred by you or third parties resulting from inaccuracy or errors of or concerning such information.