

GoldMax 300 Comm X7R, Ceramic, 0.68 uF, 10%, 50 VDC, X7R, GoldMax, Commercial Standard, Lead Spacing = 5.08mm

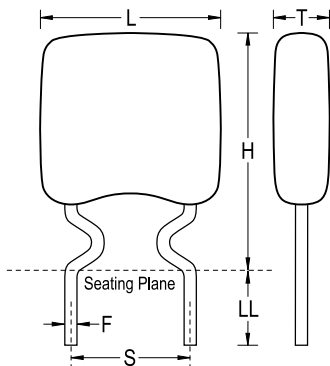

General Information	
Supplier:	KEMET
Series:	GoldMax 300 Comm X7R
Style:	Radial
Description:	GoldMax, Commercial Standard
RoHS:	Yes
Termination:	Tin
Failure Rate:	N/A
Halogen Free:	Yes

Dimensions	
L	7.11mm MAX
H	10.16mm MAX
T	4.07mm MAX
S	5.08mm +/-0.78mm
LL	7mm MIN
F	0.51mm +0.1/-0.025mm

Specifications	
Capacitance:	0.68 uF
Capacitance Tolerance:	10%
Voltage DC:	50 VDC
Dielectric Withstanding Voltage:	125 V
Temperature Range:	-55/+125C
Temperature Coefficient:	X7R
Dissipation Factor:	2.5% 25C
Aging Rate:	3% Loss/Decade Hour
Insulation Resistance:	150 MOhms

Packaging Specifications	
Packaging:	Bulk, Bag
Packaging Quantity:	250