

KEMET Part Number: C315C220J2G5TA7303
(C315C220J2G5TATR)

GoldMax 300 Comm COG, Ceramic, 22 pF, 5%, 200 VDC, COG, GoldMax, Commercial Standard, Lead Spacing = 2.54mm

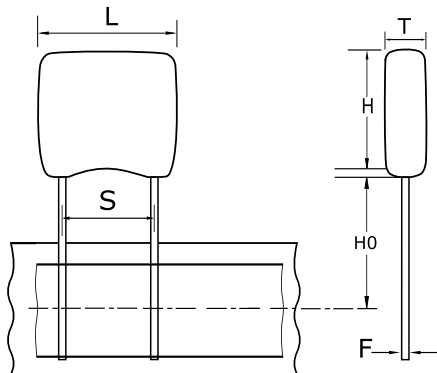

Dimensions

Dimensions	
L	3.81mm MAX
H	3.14mm MAX
T	2.54mm MAX
S	2.54mm +/-0.78mm
H0	18mm MIN
F	0.51mm +0.1/-0.025mm

Packaging Specifications

Packaging:	T&R, 305mm
Packaging Quantity:	2500

General Information

Supplier:	KEMET
Series:	GoldMax 300 Comm COG
Style:	Radial
Description:	GoldMax, Commercial Standard
RoHS:	Yes
Termination:	Tin
Failure Rate:	N/A
Halogen Free:	Yes

Specifications

Capacitance:	22 pF
Capacitance Tolerance:	5%
Voltage DC:	200 VDC
Dielectric Withstanding Voltage:	500 V
Temperature Range:	-55/+125C
Temperature Coefficient:	COG
Dissipation Factor:	0.10% 25C
Aging Rate:	0% Loss/Decade Hour
Insulation Resistance:	100 GOhms