

GoldMax 300 Comm Z5U, Ceramic, 0.027 uF, 20%, 50 VDC, Z5U, GoldMax, Commercial Standard, Lead Spacing = 2.54mm

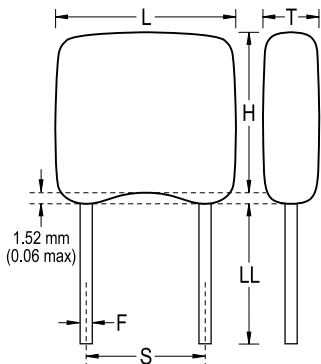

General Information	
Supplier:	KEMET
Series:	GoldMax 300 Comm Z5U
Style:	Radial
Description:	GoldMax, Commercial Standard
RoHS:	Yes
Termination:	Tin
Failure Rate:	N/A
Halogen Free:	Yes

Dimensions	
L	3.81mm MAX
H	3.14mm MAX
T	2.54mm MAX
S	2.54mm +/-0.78mm
LL	7mm MIN
F	0.51mm +0.1/-0.025mm

Specifications	
Capacitance:	0.027 uF
Capacitance Tolerance:	20%
Voltage DC:	50 VDC
Dielectric Withstanding Voltage:	125 V
Temperature Range:	-10/+85C
Temperature Coefficient:	Z5U
Dissipation Factor:	4.00% 25C
Aging Rate:	7% Loss/Decade Hour
Insulation Resistance:	3.7 GOhms

Packaging Specifications	
Packaging:	Bulk, Bag
Packaging Quantity:	500