

GoldMax 300 Comm COG, Ceramic, 360 pF, 5%, 50 VDC, COG, GoldMax, Commercial Standard, Lead Spacing = 5.08mm

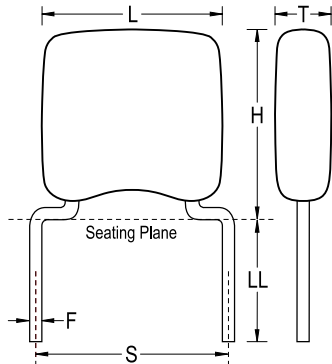

Dimensions

L	5.08mm MAX
H	6.6mm MAX
T	3.18mm MAX
S	5.08mm +/-0.78mm
LL	7mm MIN
F	0.51mm +0.1/-0.025mm

Packaging Specifications

Packaging:	Bulk, Bag
Packaging Quantity:	500

General Information

Supplier:	KEMET
Series:	GoldMax 300 Comm COG
Style:	Radial
Description:	GoldMax, Commercial Standard
RoHS:	Yes
Termination:	Tin
Failure Rate:	N/A
Halogen Free:	Yes

Specifications

Capacitance:	360 pF
Capacitance Tolerance:	5%
Voltage DC:	50 VDC
Dielectric Withstanding Voltage:	125 V
Temperature Range:	-55/+125C
Temperature Coefficient:	COG
Dissipation Factor:	0.10% 25C
Aging Rate:	0% Loss/Decade Hour
Insulation Resistance:	100 GOhms