

KEMET Part Number: C1206C222KCRACTU
(C1206C222KCRAC7800)

SMD Comm X7R HV, Ceramic, 2200 pF, 10%, 500 VDC, X7R, SMD, MLCC, High Voltage, Temperature Stable, 1206

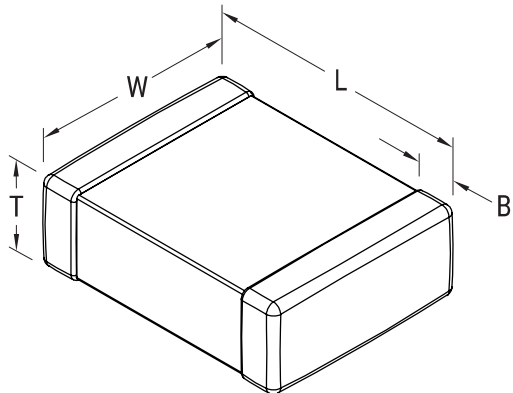

Dimensions	
L	3.2mm +/-0.2mm
W	1.6mm +/-0.2mm
T	1mm +/-0.10mm
B	0.5mm +/-0.25mm

Packaging Specifications	
Packaging:	T&R, 180mm, Plastic Tape
Packaging Quantity:	2500

General Information	
Supplier:	KEMET
Series:	SMD Comm X7R HV
Style:	SMD Chip
Description:	SMD, MLCC, High Voltage, Temperature Stable
Features:	High Voltage
RoHS:	Yes
Termination:	Tin
Marking:	No
Miscellaneous:	Note: Referee time for X7R dielectric for this part number is 1000 hours
Chip Size:	1206

Specifications	
Capacitance:	2200 pF
Capacitance Tolerance:	10%
Voltage DC:	500 VDC
Dielectric Withstanding Voltage:	750 V
Temperature Range:	-55/+125C
Temperature Coefficient:	X7R
Dissipation Factor:	2.50% 1kHz 25C
Aging Rate:	3% Loss/Decade Hour
Insulation Resistance:	100 GOhms