

KEMET Part Number: C1206C105M3RACTU
(C1206C105M3RAC7800)

SMD Comm X7R, Ceramic, 1 uF, 20%, 25 VDC, X7R, SMD, MLCC, Temperature Stable, Class II, 1206

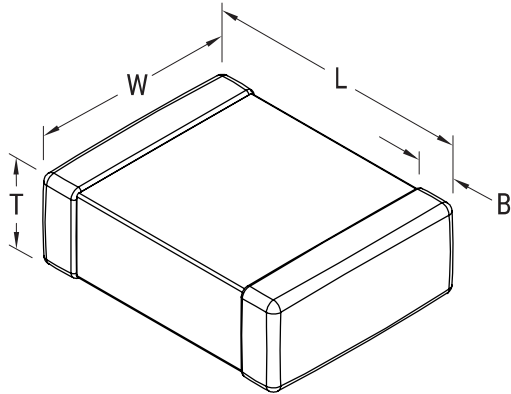

Dimensions

L	3.2mm +/-0.2mm
W	1.6mm +/-0.2mm
T	1.2mm +/-0.20mm
B	0.5mm +/-0.25mm

Packaging Specifications

Packaging:	T&R, 180mm, Plastic Tape
Packaging Quantity:	2500

General Information

Supplier:	KEMET
Series:	SMD Comm X7R
Style:	SMD Chip
Description:	SMD, MLCC, Temperature Stable, Class II
Features:	Temperature Stable, Class II
RoHS:	Yes
Termination:	Tin
Marking:	No
Miscellaneous:	Note: Referee time for X7R dielectric for this part number is 48 hours
Chip Size:	1206

Specifications

Capacitance:	1 uF
Capacitance Tolerance:	20%
Voltage DC:	25 VDC
Dielectric Withstanding Voltage:	62.5 V
Temperature Range:	-55/+125C
Temperature Coefficient:	X7R
Dissipation Factor:	3.50% 1kHz 25C
Aging Rate:	3% Loss/Decade Hour
Insulation Resistance:	500 MOhms