

KEMET Part Number: C2225C154KDRACTU
(C2225C154KDRAC7800)

SMD Comm X7R HV, Ceramic, 0.15 uF, 10%, 1000 VDC, X7R, SMD, MLCC, High Voltage, Temperature Stable, 2225

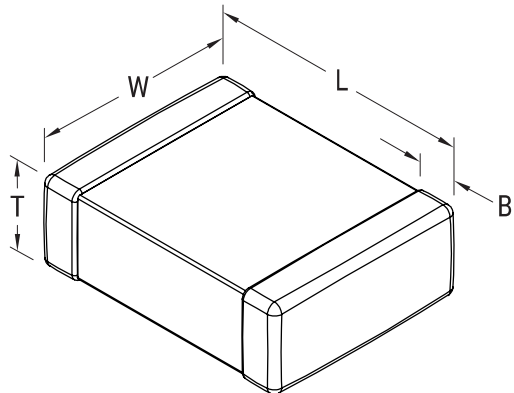

Dimensions

L	5.6mm +/-0.4mm
W	6.4mm +/-0.4mm
T	2.5mm +/-0.20mm
B	0.6mm +/-0.35mm

Packaging Specifications

Packaging:	T&R, 180mm, Plastic Tape
Packaging Quantity:	500

General Information

Supplier:	KEMET
Series:	SMD Comm X7R HV
Style:	SMD Chip
Description:	SMD, MLCC, High Voltage, Temperature Stable
Features:	High Voltage
RoHS:	Yes
Termination:	Tin
Marking:	No
Miscellaneous:	Note: Referee time for X7R dielectric for this part number is 1000 hours
Chip Size:	2225

Specifications

Capacitance:	0.15 uF
Capacitance Tolerance:	10%
Voltage DC:	1000 VDC
Dielectric Withstanding Voltage:	1,200 V
Temperature Range:	-55/+125C
Temperature Coefficient:	X7R
Dissipation Factor:	2.50% 1kHz 25C
Aging Rate:	3% Loss/Decade Hour
Insulation Resistance:	6.667 GOhms