

KEMET Part Number: C0402C439D5GACTU
(C0402C439D5GAC7867)

SMD Comm C0G, Ceramic, 4.3 pF, +/-0.5 pF, 50 VDC, C0G, SMD, MLCC, Ultra-Stable, Low Loss, Class I, 0402

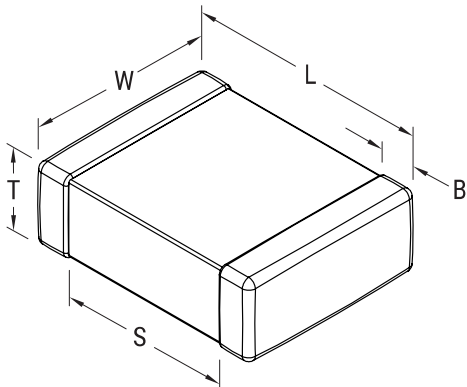

Dimensions

L	1mm +/-0.05mm
W	0.5mm +/-0.05mm
T	0.5mm +/-0.05mm
S	0.3mm MIN
B	0.3mm +/-0.1mm

Packaging Specifications

Packaging:	T&R, 180mm, Paper Tape
Packaging Quantity:	10000

General Information

Supplier:	KEMET
Series:	SMD Comm C0G
Style:	SMD Chip
Description:	SMD, MLCC, Ultra-Stable, Low Loss, Class I
Features:	Ultra-Stable, Low Loss, Class I
RoHS:	Yes
Termination:	Tin
Marking:	No
Miscellaneous:	Note: KEMET 50V rated parts may be operated at 63 Volts
Chip Size:	0402

Specifications

Capacitance:	4.3 pF
Capacitance Tolerance:	+/-0.5 pF
Voltage DC:	50 VDC
Dielectric Withstanding Voltage:	125 V
Temperature Range:	-55/+125C
Temperature Coefficient:	C0G
Dissipation Factor:	0.10% 1MHz 25C
Aging Rate:	0% Loss/Decade Hour
Insulation Resistance:	100 GOhms