

KEMET Part Number: C0603T104K4RACTU
(C0603T104K4RAC7867)

SMD COTS X7R, Ceramic, COTS, 0.1 uF, 10%, 16 VDC, X7R, SMD, MLCC, COTS, Temperature Stable, Class II, 0603

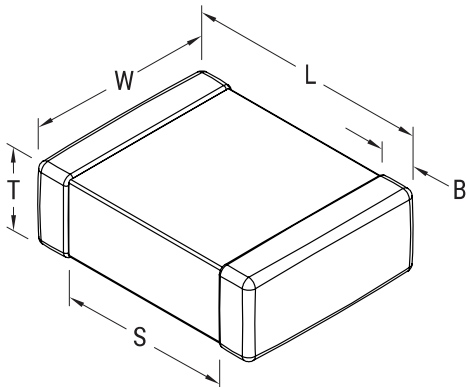

Dimensions

L	1.6mm +/-0.15mm
W	0.8mm +/-0.15mm
T	0.8mm +/-0.07mm
S	0.7mm MIN
B	0.35mm +/-0.15mm

Packaging Specifications

Packaging:	T&R, 180mm, Paper Tape
Packaging Quantity:	4000

General Information

Supplier:	KEMET
Series:	SMD COTS X7R
Style:	SMD Chip
Description:	SMD, MLCC, COTS, Temperature Stable, Class II
Features:	Temperature Stable, Class II
RoHS:	Yes
Termination:	Tin
Marking:	No
Miscellaneous:	Note: Referee time for X7R dielectric for this part number is 1000 hours
Chip Size:	0603

Specifications

Capacitance:	0.1 uF
Capacitance Tolerance:	10%
Voltage DC:	16 VDC
Dielectric Withstanding Voltage:	40 V
Temperature Range:	-55/+125C
Temperature Coefficient:	X7R
Dissipation Factor:	3.50% 1kHz 25C
Aging Rate:	3% Loss/Decade Hour
Insulation Resistance:	5 GOhms