

KEMET Part Number: C0402C104M4RACTU
(C0402C104M4RAC7867)

SMD Comm X7R, Ceramic, 0.1 uF, 20%, 16 VDC, X7R, SMD, MLCC, Temperature Stable, Class II, 0402

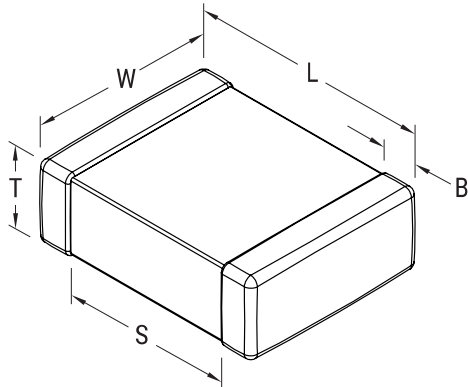

Dimensions	
L	1mm +/-0.05mm
W	0.5mm +/-0.05mm
T	0.5mm +/-0.05mm
S	0.3mm MIN
B	0.3mm +/-0.1mm

Packaging Specifications	
Packaging:	T&R, 180mm, Paper Tape
Packaging Quantity:	10000

General Information	
Supplier:	KEMET
Series:	SMD Comm X7R
Style:	SMD Chip
Description:	SMD, MLCC, Temperature Stable, Class II
Features:	Temperature Stable, Class II
RoHS:	Yes
Termination:	Tin
Marking:	No
Miscellaneous:	Note: Referee time for X7R dielectric for this part number is 48 hours
Chip Size:	0402

Specifications	
Capacitance:	0.1 uF
Capacitance Tolerance:	20%
Voltage DC:	16 VDC
Dielectric Withstanding Voltage:	40 V
Temperature Range:	-55/+125C
Temperature Coefficient:	X7R
Dissipation Factor:	3.50% 1kHz 25C
Aging Rate:	3% Loss/Decade Hour
Insulation Resistance:	5 GOhms