

ERP610 SFTY X1-760 Y1-500, Ceramic, Safety, 3300 pF, 20%, 760 VAC (X1), 500 VAC (Y1), Y5U, Lead Spacing = 12.5mm

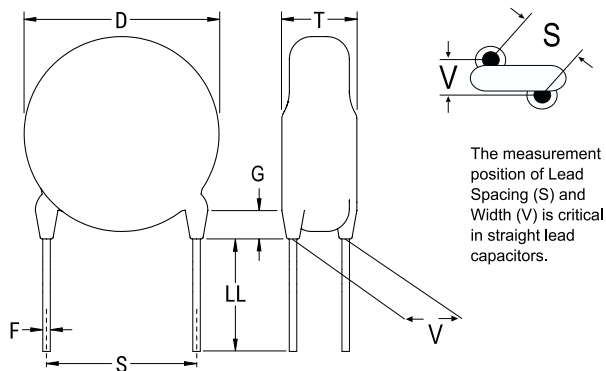

Dimensions

D	15mm MAX
T	5mm MAX
S	12.5mm NOM
LL	30mm -3mm
F	0.8mm +/-0.05mm
G	3mm MAX
V	2.1mm +/-0.5mm

Packaging Specifications

Packaging:	Bulk, Bag
-------------------	-----------

General Information

Supplier:	KEMET
Series:	ERP610 SFTY X1-760 Y1-500
Style:	Radial Disc
Description:	Ceramic Single Layer Safety Disc Capacitors
RoHS:	Yes
Termination:	Tin
Qualifications:	UL, CSA, CAN, ENEC, VDE

Specifications

Capacitance:	3300 pF
Capacitance Tolerance:	20%
Voltage AC:	760 VAC (X1), 500 VAC (Y1)
Temperature Range:	-40/+125C
Temperature Coefficient:	Y5U
Dissipation Factor:	2.5%
Insulation Resistance:	10 GOhms
Safety Class:	X1/Y1

Statements of suitability for certain applications are based on our knowledge of typical operating conditions for such applications, but are not intended to constitute - and we specifically disclaim - any warranty concerning suitability for a specific customer application or use. This Information is intended for use only by customers who have the requisite experience and capability to determine the correct products for their application. Any technical advice inferred from this Information or otherwise provided by us with reference to the use of our products is given gratis, and we assume no obligation or liability for the advice given or results obtained.