

ESK, Aluminum Electrolytic, 85C, 4,700 uF, 20%, 10 VDC, -40/+85C, Lead Spacing = 5mm

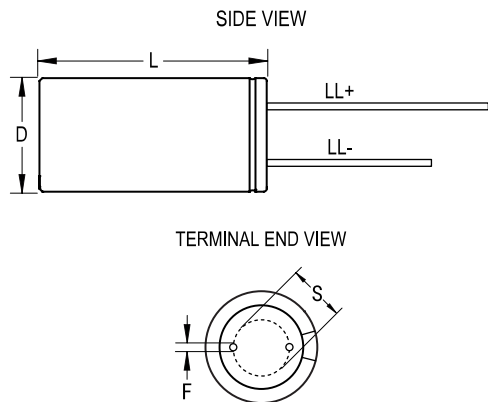

Dimensions	
D	13mm +/-0.5mm
L	25mm +2.0/-0mm
S	5mm +/-0.5mm
LL Negative	15mm MIN
LL Positive	20mm MIN
F	0.6mm NOM

Packaging Specifications	
Packaging:	Bulk, Bag
Packaging Quantity:	1600

General Information	
Supplier:	KEMET
Series:	ESK
Dielectric:	Aluminum Electrolytic
Description:	Single Ended, Aluminum Electrolytic
RoHS:	Yes
Lead:	Wire Leads

Specifications	
Capacitance:	4,700 uF
Capacitance Tolerance:	20%
Voltage DC:	10 VDC, 13 VDC (Surge)
Temperature Range:	-40/+85C
Rated Temperature:	85C
Life:	2000 Hrs
Dissipation Factor:	20.00% 120Hz 20C
Ripple Current:	1500 mAmps (120Hz 85C)
Leakage Current:	470 uA (2min 20C)
Impedance Ratio at -25C:	6
Impedance Ratio at -40C:	8