

EDK, Aluminum Electrolytic, 85C, 220 uF, 20%, 25 VDC, -40/+85C

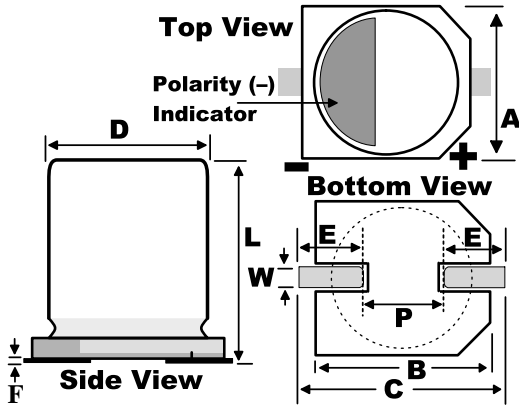

General Information	
Supplier:	KEMET
Series:	EDK
Dielectric:	Aluminum Electrolytic
Style:	SMD Can
Description:	Surface Mount, Aluminum Electrolytic
RoHS:	Yes
Lead:	V-Chip

Dimensions	
D	8mm +/-0.5mm
L	10.2mm +/-0.3mm
W	0.9mm +/-0.2mm
F	0.3mm MAX
A	8.3mm +/-0.2mm
B	8.3mm +/-0.2mm
C	10mm MAX
E	3.4mm +/-0.2mm
P	3.1mm +/-0.2mm

Specifications	
Capacitance:	220 uF
Capacitance Tolerance:	20%
Voltage DC:	25 VDC, 32 VDC (Surge)
Temperature Range:	-40/+85C
Rated Temperature:	85C
Life:	2000 Hrs
Dissipation Factor:	16.00%
Ripple Current:	230 mAmps (120Hz), 312.8 mAmps (120Hz 50C)
Leakage Current:	55 uA (2min 20C)
Impedance Ratio at -25C:	2
Impedance Ratio at -40C:	4
High Temperature Solder:	Yes

Packaging Specifications	
Packaging:	T&R, 380mm
Packaging Quantity:	500