

EDK, Aluminum Electrolytic, 85C, 10 uF, 20%, 50 VDC, -40/+85C

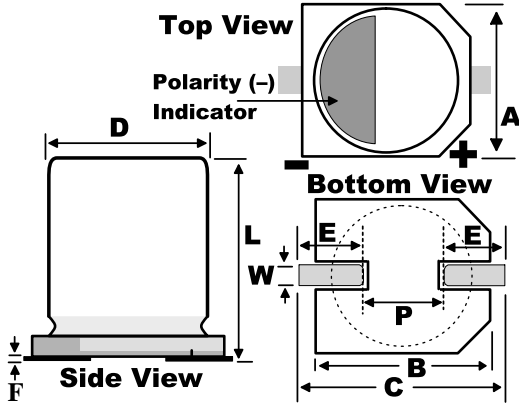

Dimensions	
D	6.3mm +/-0.5mm
L	5.4mm +0.25/-0.1mm
W	0.65mm +/-0.1mm
F	0.3mm MAX
A	6.6mm +/-0.2mm
B	6.6mm +/-0.2mm
C	7.8mm MAX
E	2.6mm +/-0.2mm
P	1.8mm +/-0.2mm

Packaging Specifications	
Packaging:	T&R, 380mm
Packaging Quantity:	1000

General Information	
Supplier:	KEMET
Series:	EDK
Dielectric:	Aluminum Electrolytic
Style:	SMD Can
Description:	Surface Mount, Aluminum Electrolytic
RoHS:	Yes
Lead:	V-Chip

Specifications	
Capacitance:	10 uF
Capacitance Tolerance:	20%
Voltage DC:	50 VDC, 63 VDC (Surge)
Temperature Range:	-40/+85C
Rated Temperature:	85C
Life:	2000 Hrs
Dissipation Factor:	12.00%
Ripple Current:	35 mAmps (120Hz), 47.6 mAmps (120Hz 50C)
Leakage Current:	5 uA (2min 20C)
Impedance Ratio at -25C:	2
Impedance Ratio at -40C:	3
High Temperature Solder:	Yes