

ELG, Aluminum Electrolytic, 105C, 120 uF, 20%, 450 VDC, -25/+105C

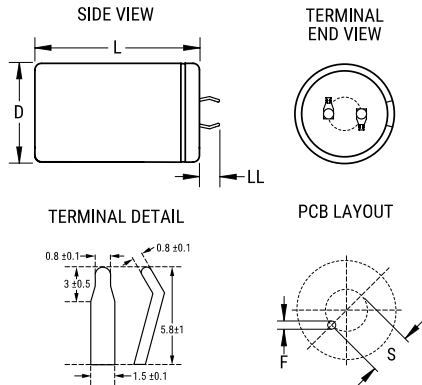

Dimensions

D	22mm +/-1mm
L	45mm +/-2mm
S	10mm +/-0.5mm
LL	5.8mm +/-1mm
F	2mm +/-0.1mm

Packaging Specifications

Packaging:	Bulk, Bag
-------------------	-----------

General Information

Supplier:	KEMET
Series:	ELG
Dielectric:	Aluminum Electrolytic
Description:	Snap-In, Aluminum Electrolytic
RoHS:	Yes
Lead:	2 Pin

Specifications

Capacitance:	120 uF
Capacitance Tolerance:	20%
Voltage DC:	450 VDC, 500 VDC (Surge)
Temperature Range:	-25/+105C
Rated Temperature:	105C
Life:	2000 Hrs
Dissipation Factor:	20.00% 120Hz 20C
Resistance:	532 mOhms (20kHz)
Ripple Current:	700 mAmps (120Hz)
Leakage Current:	1100 uA (5min 20C)