

ELG, Aluminum Electrolytic, 105C, 470 uF, 20%, 450 VDC, -25/+105C

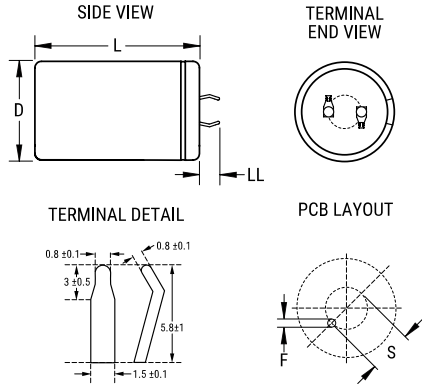

**Dimensions**

<b>D</b>	35mm +/-1mm
<b>L</b>	50mm +/-2mm
<b>S</b>	10mm +/-0.5mm
<b>LL</b>	5.8mm +/-1mm
<b>F</b>	2mm +/-0.1mm

**Packaging Specifications**

<b>Packaging:</b>	Bulk, Bag
-------------------	-----------

**General Information**

<b>Supplier:</b>	KEMET
<b>Series:</b>	ELG
<b>Dielectric:</b>	Aluminum Electrolytic
<b>Description:</b>	Snap-In, Aluminum Electrolytic
<b>RoHS:</b>	Yes
<b>Lead:</b>	2 Pin

**Specifications**

<b>Capacitance:</b>	470 uF
<b>Capacitance Tolerance:</b>	20%
<b>Voltage DC:</b>	450 VDC, 500 VDC (Surge)
<b>Temperature Range:</b>	-25/+105C
<b>Rated Temperature:</b>	105C
<b>Life:</b>	2000 Hrs
<b>Dissipation Factor:</b>	20.00% 120Hz 20C
<b>Resistance:</b>	145 mOhms (20kHz)
<b>Ripple Current:</b>	1700 mAmps (120Hz)
<b>Leakage Current:</b>	3000 uA (5min 20C)