

C4BS, Film, Metallized Polypropylene, Power, 1 uF, 5%, 600 VAC, 1000 VDC, 70C, Lead Spacing = 22mm

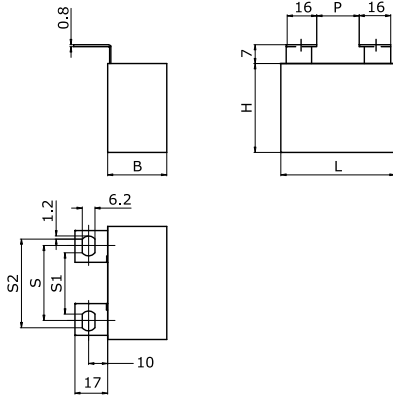

Dimensions

L	41.5mm NOM
H	40mm NOM
T	20mm NOM
S	22mm NOM
S1	16mm NOM
P	6mm NOM

Packaging Specifications

Packaging:	Bulk, Bag
Packaging Quantity:	52

General Information

Supplier:	KEMET
Series:	C4BS
Dielectric:	Metallized Polypropylene
Style:	Radial
Features:	IGBT Circuit
RoHS:	Yes
Lead:	Flat Tabs
Miscellaneous:	Kemet Style B Tabs

Specifications

Capacitance:	1 uF
Capacitance Tolerance:	5%
Voltage AC:	600 VAC
Voltage DC:	1000 VDC
Temperature Range:	-40/+85C
Rated Temperature:	70C
Max dV/dt:	827 V/us
Resistance:	3.7 mOhms (100kHz)
Ripple Current:	23 Amps (100kHz 70C), 827 Amps (Peak)
Inductance:	41 nH