

C44U, Film, Metallized Polypropylene, DC Link, 250 uF, 10%, 1100 VDC

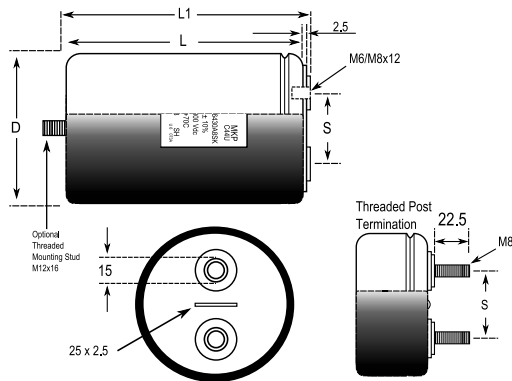

General Information	
Supplier:	KEMET
Series:	C44U
Dielectric:	Metallized Polypropylene
Style:	Can
Features:	Heavy Duty
RoHS:	Yes
Lead:	Screw Terminals M6
Miscellaneous:	Thermal Resistance = 4.1 C/W. Weight = 824 grams

Dimensions	
D	85mm +/-1mm
L	140mm +/-2mm
S	31.7mm +/-0.2mm

Specifications	
Capacitance:	250 uF
Capacitance Tolerance:	10%
Voltage DC:	1100 VDC
Temperature Range:	-40/+85C
Rated Temperature:	75C
Max dV/dt:	9 V/us
Resistance:	3.6 mOhms (10kHz)
Ripple Current:	55 Amps (10kHz 40C), 2250 Amps (Peak)
Inductance:	60 nH

Packaging Specifications	
Mounting:	Bolt - M12x16
Packaging:	Bulk, Bag
Packaging Quantity:	5