

R73, Film, Film/Foil Polypropylene, Automotive Grade, 2200 pF, 5%, 1250 VDC, 85C, Lead Spacing = 15mm

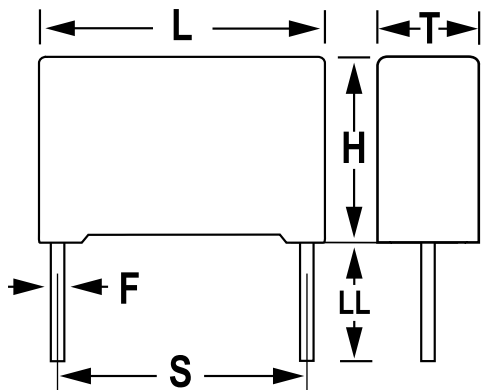

General Information	
Supplier:	KEMET
Series:	R73
Dielectric:	Film/Foil Polypropylene
Style:	Radial
Features:	Automotive Grade, Pulse
RoHS:	Yes
Lead:	Wire Leads
Qualifications:	AEC-Q200
AEC-Q200:	Yes
Miscellaneous:	Above 85C DC And AC Voltage Derating Is 1.25%/C

Dimensions	
L	18mm +0.3mm
H	11mm +0.1mm
T	5mm +0.2mm
S	15mm +/-0.4mm
LL	30mm +5mm
F	0.8mm +/-0.05mm

Specifications	
Capacitance:	2200 pF
Capacitance Tolerance:	5%
Voltage AC:	450 VAC
Voltage DC:	1250 VDC
Temperature Range:	-55/+105C
Rated Temperature:	85C
Dissipation Factor:	0.03% 1kHz, 0.04% 10kHz, 0.10% 100kHz
Insulation Resistance:	100 GOhms
Max dV/dt:	30000 V/us
Inductance:	10 nH

Packaging Specifications	
Packaging:	Bulk, Bag
Packaging Quantity:	1000