

C4BS, Film, Metallized Polypropylene, Power, 3 uF, 5%, 630 VAC, 1200 VDC, 70C, Lead Spacing = 37mm

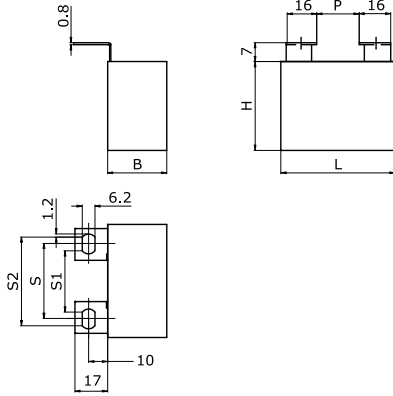

Dimensions	
L	57.5mm NOM
H	50mm NOM
T	35mm NOM
S	37mm NOM
S1	31mm NOM
P	21mm NOM

Packaging Specifications	
Packaging:	Bulk, Bag
Packaging Quantity:	21

General Information	
Supplier:	KEMET
Series:	C4BS
Dielectric:	Metallized Polypropylene
Style:	Radial
Features:	IGBT Circuit
RoHS:	Yes
Lead:	Flat Tabs
Miscellaneous:	Kemet Style B Tabs

Specifications	
Capacitance:	3 uF
Capacitance Tolerance:	5%
Voltage AC:	630 VAC
Voltage DC:	1200 VDC
Temperature Range:	-40/+85C
Rated Temperature:	70C
Max dV/dt:	598 V/us
Resistance:	2.5 mOhms (100kHz)
Ripple Current:	37 Amps (100kHz 70C), 1793 Amps (Peak)
Inductance:	48 nH