

C4BS, Film, Metallized Polypropylene, Power, 0.47 uF, 5%, 550 VAC, 850 VDC, 70C, Lead Spacing = 25mm

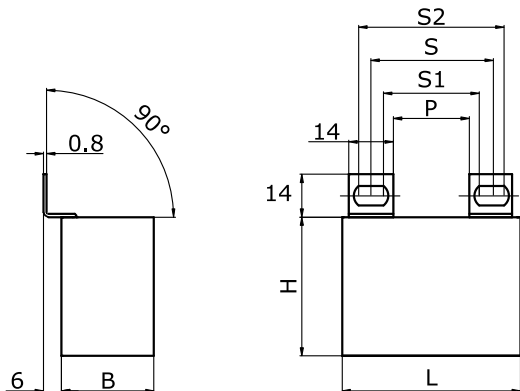

**Dimensions**

<b>L</b>	41.5mm NOM
<b>H</b>	40mm NOM
<b>T</b>	20mm NOM
<b>S</b>	25mm +/-0.2mm
<b>S1</b>	21.5mm +/-0.2mm
<b>P</b>	10.5mm NOM

**Packaging Specifications**

<b>Packaging:</b>	Bulk, Bag
<b>Packaging Quantity:</b>	40

**General Information**

<b>Supplier:</b>	KEMET
<b>Series:</b>	C4BS
<b>Dielectric:</b>	Metallized Polypropylene
<b>Style:</b>	Radial
<b>Features:</b>	IGBT Circuit
<b>RoHS:</b>	Yes
<b>Lead:</b>	Flat Tabs
<b>Miscellaneous:</b>	Kemet Style A Tabs

**Specifications**

<b>Capacitance:</b>	0.47 uF
<b>Capacitance Tolerance:</b>	5%
<b>Voltage AC:</b>	550 VAC
<b>Voltage DC:</b>	850 VDC
<b>Temperature Range:</b>	-40/+85C
<b>Rated Temperature:</b>	70C
<b>Max dV/dt:</b>	758 V/us
<b>Resistance:</b>	8.2 mOhms (100kHz)
<b>Ripple Current:</b>	16 Amps (100kHz 70C), 356 Amps (Peak)
<b>Inductance:</b>	41 nH