

C4C, Film, Metallized Polypropylene, Power, 0.56 uF, 5%, 630 VAC, 2000 VDC, 70C

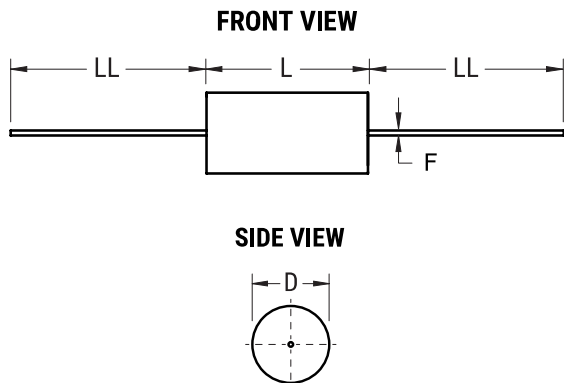

Dimensions	
D	29mm NOM
L	58mm NOM
LL	40mm +/-5mm

Packaging Specifications	
Packaging:	Bulk, Bag
Packaging Quantity:	30

General Information	
Supplier:	KEMET
Series:	C4C
Dielectric:	Metallized Polypropylene
Style:	Axial
RoHS:	Yes
Lead:	Wire Leads
Miscellaneous:	Polyester Tape & Resin Protection

Specifications	
Capacitance:	0.56 uF
Capacitance Tolerance:	5%
Voltage AC:	630 VAC
Voltage DC:	2000 VDC
Temperature Range:	-40/+85C
Rated Temperature:	70C
Dissipation Factor:	0.05%
Max dV/dt:	400 V/us
Resistance:	6.1 mOhms (100kHz)
Ripple Current:	12 Amps (100kHz 70C), 224 Amps (Peak)

Statements of suitability for certain applications are based on our knowledge of typical operating conditions for such applications, but are not intended to constitute - and we specifically disclaim - any warranty concerning suitability for a specific customer application or use. This Information is intended for use only by customers who have the requisite experience and capability to determine the correct products for their application. Any technical advice inferred from this Information or otherwise provided by us with reference to the use of our products is given gratis, and we assume no obligation or liability for the advice given or results obtained.