

C4G, Film, Metallized Polypropylene, Power, 5 uF, 5%, 400 VAC, 700 VDC, 70C

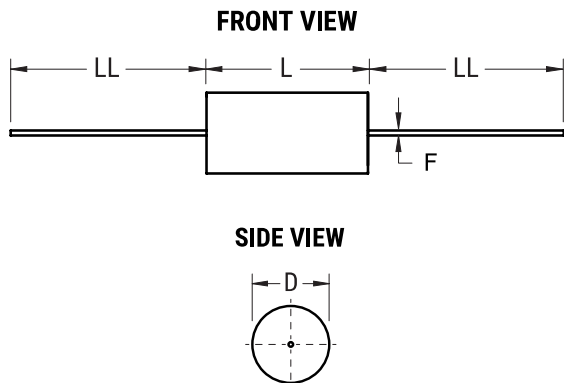

General Information	
Supplier:	KEMET
Series:	C4G
Dielectric:	Metallized Polypropylene
Style:	Axial
Features:	Switching
RoHS:	Yes
Lead:	Wire Leads
Miscellaneous:	Polyester Tape & Resin Protection

Dimensions	
D	30.5mm MAX
L	58mm MAX
LL	40mm +/-5mm

Packaging Specifications	
Packaging:	Bulk, Bag
Packaging Quantity:	30

Specifications	
Capacitance:	5 uF
Capacitance Tolerance:	5%
Voltage AC:	400 VAC
Voltage DC:	700 VDC
Temperature Range:	-40/+85C
Rated Temperature:	70C
Dissipation Factor:	0.05%
Max dV/dt:	40 V/us
Resistance:	7.5 mOhms (100kHz)
Ripple Current:	12 Amps (100kHz 70C), 200 Amps (Peak)