

C4G, Film, Metallized Polypropylene, Power, 2 uF, 5%, 450 VAC, 850 VDC, 70C

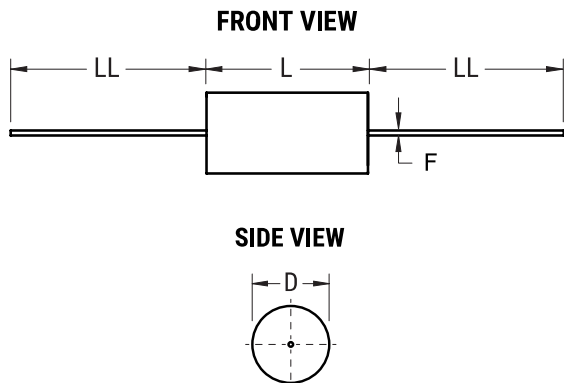

General Information	
Supplier:	KEMET
Series:	C4G
Dielectric:	Metallized Polypropylene
Style:	Axial
Features:	Switching
RoHS:	Yes
Lead:	Wire Leads
Miscellaneous:	Polyester Tape & Resin Protection

Dimensions	
D	28.5mm MAX
L	44mm MAX
LL	40mm +/-5mm

Packaging Specifications	
Packaging:	Bulk, Bag
Packaging Quantity:	50

Specifications	
Capacitance:	2 uF
Capacitance Tolerance:	5%
Voltage AC:	450 VAC
Voltage DC:	850 VDC
Temperature Range:	-40/+85C
Rated Temperature:	70C
Dissipation Factor:	0.05%
Max dV/dt:	140 V/us
Resistance:	3.1 mOhms (100kHz)
Ripple Current:	12 Amps (100kHz 70C), 280 Amps (Peak)

Statements of suitability for certain applications are based on our knowledge of typical operating conditions for such applications, but are not intended to constitute - and we specifically disclaim - any warranty concerning suitability for a specific customer application or use. This Information is intended for use only by customers who have the requisite experience and capability to determine the correct products for their application. Any technical advice inferred from this Information or otherwise provided by us with reference to the use of our products is given gratis, and we assume no obligation or liability for the advice given or results obtained.