

C4G, Film, Metallized Polypropylene, Power, 2.5 uF, 5%, 450 VAC, 850 VDC, 70C

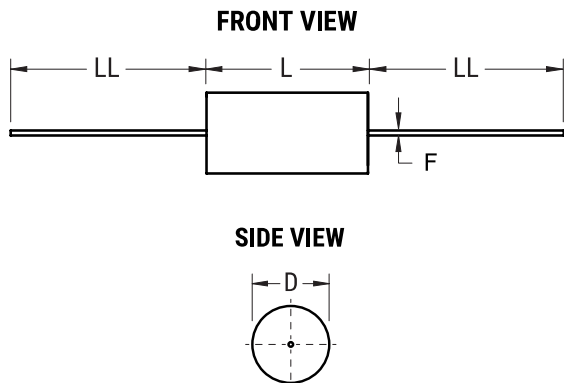

General Information	
Supplier:	KEMET
Series:	C4G
Dielectric:	Metallized Polypropylene
Style:	Axial
Features:	Switching
RoHS:	Yes
Lead:	Wire Leads
Miscellaneous:	Polyester Tape & Resin Protection

Dimensions	
D	31.5mm MAX
L	44mm MAX
LL	40mm +/-5mm

Packaging Specifications	
Packaging:	Bulk, Bag
Packaging Quantity:	50

Specifications	
Capacitance:	2.5 uF
Capacitance Tolerance:	5%
Voltage AC:	450 VAC
Voltage DC:	850 VDC
Temperature Range:	-40/+85C
Rated Temperature:	70C
Dissipation Factor:	0.05%
Max dV/dt:	140 V/us
Resistance:	2.9 mOhms (100kHz)
Ripple Current:	12 Amps (100kHz 70C), 350 Amps (Peak)