

C4BS, Film, Metallized Polypropylene, Power, 2.5 uF, 5%, 550 VAC, 850 VDC, 70C, Lead Spacing = 37mm

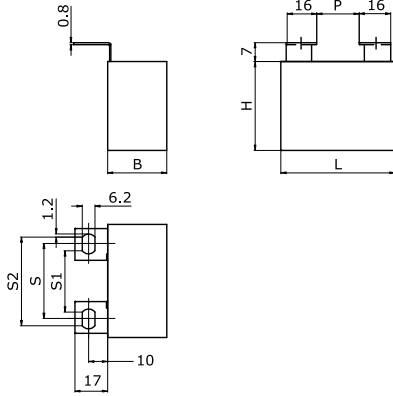

Dimensions

L	57.5mm NOM
H	45mm NOM
T	30mm NOM
S	37mm NOM
S1	31mm NOM
P	21mm NOM

Packaging Specifications

Packaging:	Bulk, Bag
Packaging Quantity:	24

General Information

Supplier:	KEMET
Series:	C4BS
Dielectric:	Metallized Polypropylene
Style:	Radial
Features:	IGBT Circuit
RoHS:	Yes
Lead:	Flat Tabs
Miscellaneous:	Kemet Style B Tabs

Specifications

Capacitance:	2.5 uF
Capacitance Tolerance:	5%
Voltage AC:	550 VAC
Voltage DC:	850 VDC
Temperature Range:	-40/+85C
Rated Temperature:	70C
Max dV/dt:	469 V/us
Resistance:	1.7 mOhms (100kHz)
Ripple Current:	39 Amps (100kHz 70C), 1174 Amps (Peak)
Inductance:	45 nH