

C4BS, Film, Metallized Polypropylene, Power, 1 uF, 5%, 630 VAC, 1200 VDC, 70C, Lead Spacing = 22mm

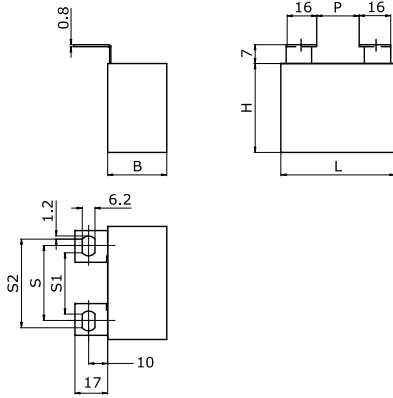

Dimensions

L	42.5mm NOM
H	37mm NOM
T	28mm NOM
S	22mm NOM
S1	16mm NOM
P	6mm NOM

Packaging Specifications

Packaging:	Bulk, Bag
Packaging Quantity:	36

General Information

Supplier:	KEMET
Series:	C4BS
Dielectric:	Metallized Polypropylene
Style:	Radial
Features:	IGBT Circuit
RoHS:	Yes
Lead:	Flat Tabs
Miscellaneous:	Kemet Style B Tabs

Specifications

Capacitance:	1 uF
Capacitance Tolerance:	5%
Voltage AC:	630 VAC
Voltage DC:	1200 VDC
Temperature Range:	-40/+85C
Rated Temperature:	70C
Max dV/dt:	965 V/us
Resistance:	3.3 mOhms (100kHz)
Ripple Current:	27 Amps (100kHz 70C), 965 Amps (Peak)
Inductance:	36 nH