

C4BS, Film, Metallized Polypropylene, Power, 0.047 uF, 5%, 750 VAC, 3000 VDC, 70C, Lead Spacing = 25mm

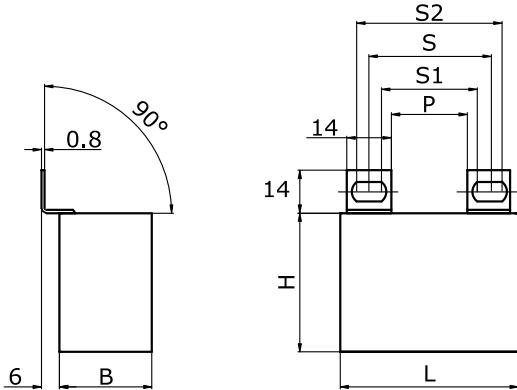

Dimensions	
L	41.5mm NOM
H	40mm NOM
T	20mm NOM
S	25mm +/-0.2mm
S1	21.5mm +/-0.2mm
P	10.5mm NOM

Packaging Specifications	
Packaging:	Bulk, Bag
Packaging Quantity:	52

General Information	
Supplier:	KEMET
Series:	C4BS
Dielectric:	Metallized Polypropylene
Style:	Radial
Features:	IGBT Circuit
RoHS:	Yes
Lead:	Flat Tabs
Miscellaneous:	Kemet Style A Tabs

Specifications	
Capacitance:	0.047 uF
Capacitance Tolerance:	5%
Voltage AC:	750 VAC
Voltage DC:	3000 VDC
Temperature Range:	-40/+85C
Rated Temperature:	70C
Max dV/dt:	2068 V/us
Resistance:	36.6 mOhms (100kHz)
Ripple Current:	8 Amps (100kHz 70C), 97 Amps (Peak)
Inductance:	41 nH