

**KEMET Part Number: PZB300MC13R30**  
(P300PL104M275AC472)

PZB300/P300, Film, Metallized Paper, Safety, 0.1 uF, 20%, 100C, Lead Spacing = 20mm

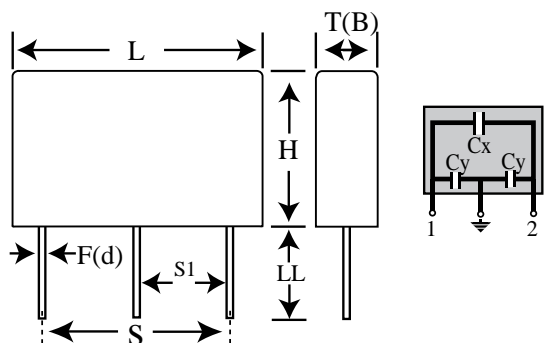

Note: '()' correspond to the letters used in the product bulletin

**General Information**

<b>Supplier:</b>	KEMET
<b>Series:</b>	PZB300/P300
<b>Dielectric:</b>	Metallized Paper
<b>Style:</b>	Radial
<b>Features:</b>	EMI Safety
<b>RoHS:</b>	Yes
<b>Lead:</b>	3 Leads
<b>Qualifications:</b>	ENEC, UL, cUL
<b>Construction:</b>	Molded
<b>Miscellaneous:</b>	y2_cap_value= 0.0047 uF

**Dimensions**

<b>L</b>	24mm MAX
<b>H</b>	16mm MAX
<b>T</b>	12.5mm MAX
<b>S</b>	20mm +/-0.5mm
<b>S1</b>	10mm NOM
<b>LL</b>	30mm +5mm
<b>F</b>	0.8mm +/-0.05mm

**Specifications**

<b>Capacitance:</b>	0.1 uF
<b>Capacitance Tolerance:</b>	20%
<b>Voltage AC:</b>	275 VAC
<b>Temperature Range:</b>	-40/+100C
<b>Rated Temperature:</b>	100C
<b>Dissipation Factor:</b>	1.3% 1kHz
<b>Insulation Resistance:</b>	12 GOhms
<b>Max dV/dt:</b>	600 V/us
<b>Safety Class:</b>	Delta EMI X2+Y2+Y2

**Packaging Specifications**

<b>Packaging:</b>	Bulk, Bag
<b>Packaging Quantity:</b>	150