

R47_X2_440, Film, Metallized Polypropylene, Automotive Safety, 0.1 uF, 10%, 440 VAC (X2), 1000 VDC, 110C, Lead Spacing = 22.5mm

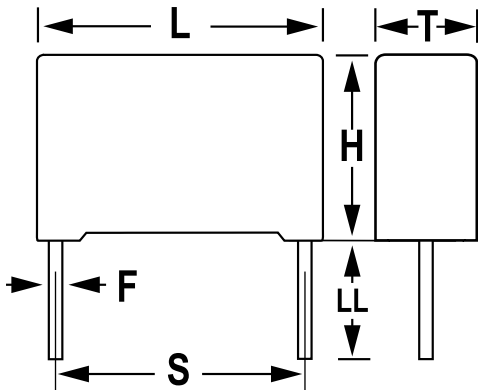

General Information	
Supplier:	KEMET
Series:	R47_X2_440
Dielectric:	Metallized Polypropylene
Style:	Radial
Features:	Automotive Grade, EMI Safety
RoHS:	Yes
Lead:	Wire Leads
Qualifications:	AEC-Q200, ENEC, UL, cUL
AEC-Q200:	Yes

Dimensions	
L	26.5mm +0.3mm
H	16mm +0.1mm
T	7mm +0.2mm
S	22.5mm +/-0.4mm
LL	25mm +2/-1mm
F	0.8mm +/-0.05mm

Specifications	
Capacitance:	0.1 uF
Capacitance Tolerance:	10%
Voltage AC:	440 VAC (X2)
Voltage DC:	1000 VDC
Temperature Range:	-40/+110C
Rated Temperature:	110C
Dissipation Factor:	0.10% 1kHz
Insulation Resistance:	100 GOhms
Max dV/dt:	300 V/us
Safety Class:	X2

Packaging Specifications	
Packaging:	Bulk, Bag
Packaging Quantity:	500