

A765, Polymer Aluminum, 105C LowZ, 270 uF, 20%, 10 VDC, -55/+105C

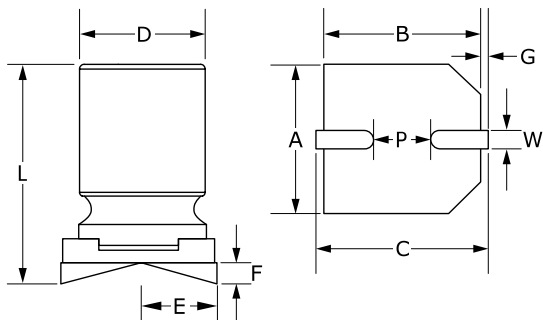

Dimensions

D	8mm +/-0.5mm
L	9.7mm +/-0.3mm
W	0.8 - 1.1mm
F	0.2mm MAX
A	8.3mm +/-0.2mm
B	8.3mm +/-0.2mm
C	9mm +/-0.2mm
E	2.9mm +/-0.2mm
G	0.35mm +/-0.2mm
P	3.2mm +/-0.2mm

Packaging Specifications

Packaging:	T&R, 380mm
Packaging Quantity:	500

General Information

Supplier:	KEMET
Series:	A765
Dielectric:	Polymer Aluminum
Style:	SMD Can
Description:	Surface Mount, Polymer Aluminum
RoHS:	Yes
Lead:	V-Chip

Specifications

Capacitance:	270 uF
Capacitance Tolerance:	20%
Voltage DC:	10 VDC, 11.5 VDC (Surge)
Temperature Range:	-55/+105C
Rated Temperature:	105C
Life:	2000 Hrs
Resistance:	20 mOhms (100kHz 20C)
Ripple Current:	3600 mAmps (100kHz 105C)
Leakage Current:	540 uA (2min 20C)
Impedance Ratio at -25C:	1.25
Impedance Ratio at -55C:	1.25
High Temperature Solder:	No