

A765, Polymer Aluminum, 105C LowZ, 270 uF, 20%, 25 VDC, -55/+105C

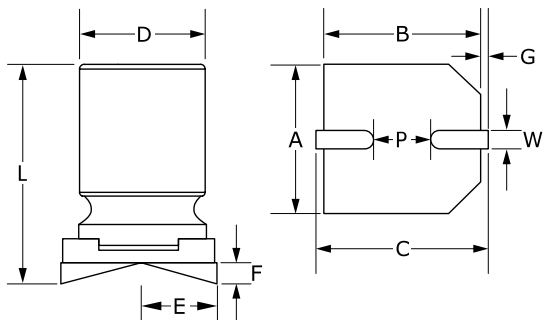

Dimensions	
D	10mm +/-0.5mm
L	12.6mm +/-0.3mm
W	0.8 - 1.1mm
F	0.2mm MAX
A	10.3mm +/-0.2mm
B	10.3mm +/-0.2mm
C	11mm +/-0.2mm
E	3.2mm +/-0.2mm
G	0.35mm +/-0.2mm
P	4.6mm +/-0.2mm

Packaging Specifications	
Packaging:	T&R, 380mm
Packaging Quantity:	400

General Information	
Supplier:	KEMET
Series:	A765
Dielectric:	Polymer Aluminum
Style:	SMD Can
Description:	Surface Mount, Polymer Aluminum
RoHS:	Yes
Lead:	V-Chip

Specifications	
Capacitance:	270 uF
Capacitance Tolerance:	20%
Voltage DC:	25 VDC, 28.7 VDC (Surge)
Temperature Range:	-55/+105C
Rated Temperature:	105C
Life:	2000 Hrs
Resistance:	50 mOhms (100kHz 20C)
Ripple Current:	3800 mAmps (100kHz 105C)
Leakage Current:	1350 uA (2min 20C)
Impedance Ratio at -25C:	1.25
Impedance Ratio at -55C:	1.25
High Temperature Solder:	No