

KEMET, ESD-R-NC23, EMI Cores, Noise Suppression

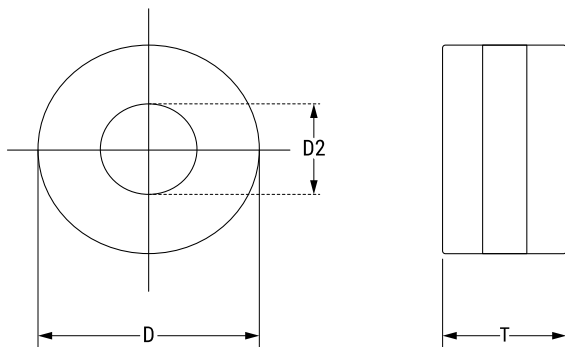

General Information	
Series:	ESD-R-NC23
Style:	Round - Toroidal
Cable Type:	Round Cable
Description:	EMI Core Solid, Large-Size Ring Type, For Round Cables
Features:	Low and High Frequency Range, Flame Retardancy
RoHS:	Yes
Qualifications:	UL94V-0
Case Color:	Black with yellow tape
Materials:	Nanocrystal

Dimensions	
D	61mm MAX
D2	33.2mm +/-1mm
T	25mm MAX

Specifications	
Temperature Range:	-40/+120C
Effective Frequency:	10 MHz (AM Band Range) or 300 MHz (FM Band Range)

Packaging Specifications	
Packaging:	Tray, Box
Packaging Quantity:	60
Weight:	186 g

Statements of suitability for certain applications are based on our knowledge of typical operating conditions for such applications, but are not intended to constitute - and we specifically disclaim - any warranty concerning suitability for a specific customer application or use. This Information is intended for use only by customers who have the requisite experience and capability to determine the correct products for their application. Any technical advice inferred from this Information or otherwise provided by us with reference to the use of our products is given gratis, and we assume no obligation or liability for the advice given or results obtained.