

KEMET, SSR10V/H, AC Line Filters, Common Mode, 0.022 H

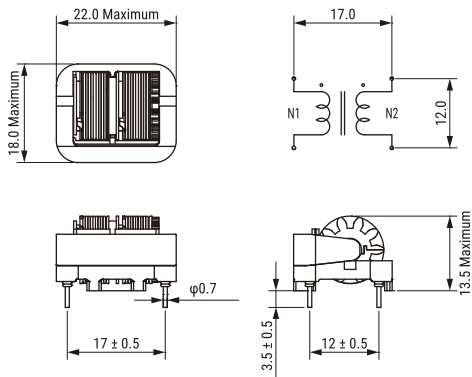

Dimensions	
L	22mm MAX
T	18mm MAX
H	13.5mm MAX
LL	3.5mm +/-0.5mm
S	12mm +/-0.5mm

Packaging Specifications	
Packaging:	Tray
Packaging Quantity:	300
Weight:	9 g

General Information	
Series:	SSR10V/H
Style:	Through-Hole
Features:	Small Standard Common Mode, High Permeability, Compact Size, Low Profile, Light Weight, High Impedance, Strong Inductance
RoHS:	Yes
Miscellaneous:	55 (K) Temperature Rise Max.

Specifications	
Voltage AC:	250 VAC
Inductance:	22 mH (10 kHz)
Current:	800 mA
Temperature Range:	-25/+120C
DC Resistance:	650 mOhms