

**KEMET Part Number: T541X107M025AH6710**  
(04052-060B)

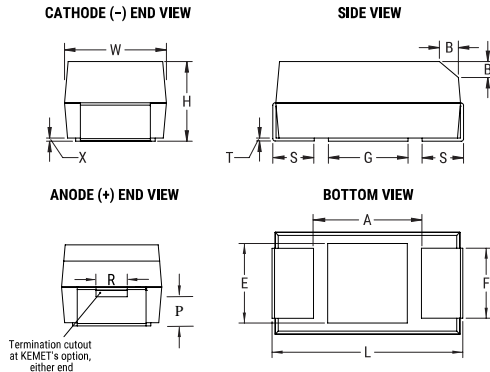

T541\_COTS, Tantalum, Polymer Tantalum, COTS Multi-Anode, 100 uF, 20%, 25 VDC, SMD, Polymer, Molded, COTS, Multi-Anode, Low ESR, N/A, 60 mOhms, 7343, Height Max = 4.3mm



Dimensions	
Footprint	7343
L	7.3mm +/-0.3mm
W	4.3mm +/-0.3mm
H	4mm +/-0.3mm
T	0.13mm REF
S	1.3mm +/-0.3mm
F	2.4mm +/-0.1mm
A	3.8mm MIN
B	0.5mm +/-0.15mm
E	3.5mm REF
G	3.5mm REF
P	1.7mm REF
R	1mm REF
X	0.1mm +/-0.1mm

Packaging Specifications	
Weight:	410.89 mg
Packaging:	T&R, 178mm
Packaging Quantity:	500

General Information	
Supplier:	KEMET
Series:	T541_COTS
Dielectric:	Polymer Tantalum
Style:	SMD Chip
Description:	SMD, Polymer, Molded, COTS, Multi-Anode, Low ESR
Features:	Non-Combustible, Multiple Anode, Low ESR, COTS
RoHS:	No
Prop 65:	<b>WARNING:</b> Cancer and reproductive harm - <a href="http://www.p65warnings.ca.gov">www.p65warnings.ca.gov</a>
REACH:	SVHC (Pb - CAS 7439-92-1)
Termination:	Solder Coated
Qualifications:	DLA Drawing 04052
Notes:	In polarity stripe, at KEMET's option, type may be indicated: no symbol = Standard (or low leakage) MnO2 tantalum chip, O = LowESR T494, R = Low ESR T495, F = Fused T496, HT = 150C rated T498 (or B45196P, B45198P), H = 175C rated T499, H2 = 200C rated T50
Shelf Life:	52 Weeks
MSL:	3

Specifications	
Capacitance:	100 uF
Capacitance Tolerance:	20%
Voltage DC:	25 VDC (105C), 16.75 VDC (125C)
Temperature Range:	-55/+125C
Rated Temperature:	105C
Dissipation Factor:	10.00% 120Hz 25C
Failure Rate:	N/A
Resistance:	60 mOhms (100kHz 25C)
Ripple Current:	2121 mA (100kHz 45C)
Leakage Current:	250 uA (5min 25C)
Testing and Reliability:	10 Cycles Surge Current Testing At -55C +0C/-5C And +85C +/-5C After Voltage Aging

Statements of suitability for certain applications are based on our knowledge of typical operating conditions for such applications, but are not intended to constitute - and we specifically disclaim - any warranty concerning suitability for a specific customer application or use. This Information is intended for use only by customers who have the requisite experience and capability to determine the correct products for their application. Any technical advice inferred from this Information or otherwise provided by us with reference to the use of our products is given gratis, and we assume no obligation or liability for the advice given or results obtained.

