

KEMET, SSR21NV/NH, AC Line Filters, Common Mode, 0.0325 H

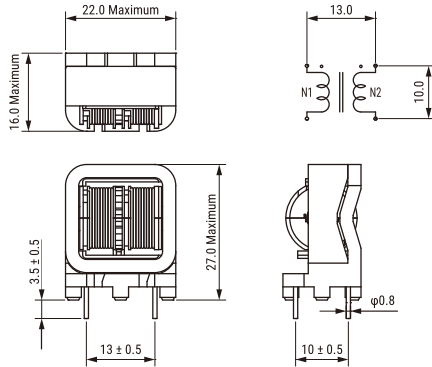

**Dimensions**

<b>L</b>	22mm MAX
<b>T</b>	16mm MAX
<b>H</b>	27mm MAX
<b>LL</b>	3.5mm +/-0.5mm
<b>S</b>	10mm +/-0.5mm

**Packaging Specifications**

<b>Packaging:</b>	Tray
<b>Packaging Quantity:</b>	450
<b>Weight:</b>	14.5 g

**General Information**

<b>Series:</b>	SSR21NV/NH
<b>Style:</b>	Through-Hole
<b>Features:</b>	Compact Size, Light Weight, High Performance, Low DCR, High Impedance, Strong Inductance
<b>RoHS:</b>	Yes
<b>Miscellaneous:</b>	45 (K) Temperature Rise Max.

**Specifications**

<b>Voltage AC:</b>	250 VAC
<b>Inductance:</b>	32.5 mH (10 kHz)
<b>Current:</b>	800 mA
<b>Temperature Range:</b>	-25/+120C
<b>DC Resistance:</b>	470 mOhms