

KEMET, HHBC, AC Line Filters, Normal Mode, 174 uH, 20%

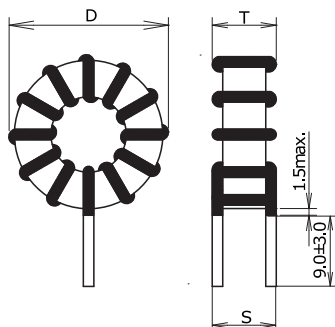

Dimensions	
D	57.6mm MAX
T	30.9mm MAX
LL	9mm +/-3mm
S	24mm NOM

Packaging Specifications	
Packaging:	Tray
Packaging Quantity:	45
Weight:	245 g

General Information	
Series:	HHBC
Style:	Through-Hole
Features:	Noise Solution, Switching Power Supply Outlets, DC-DC Converter
RoHS:	Yes
Miscellaneous:	50 (K) Temperature Rise Max.

Specifications	
Inductance:	174 uH
Inductance Tolerance:	20%
Current:	20 A
Temperature Range:	-40/+125C
DC Resistance:	11.8 mOhms