

KEMET, PHBC, AC Line Filters, Normal Mode, 38 uH, 20%

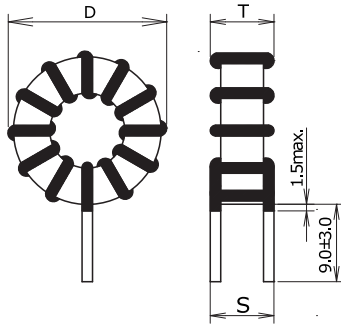

Dimensions

D	21.5mm MAX
T	11.7mm MAX
LL	9mm +/-3mm
S	8mm NOM

Packaging Specifications

Packaging:	Tray
Packaging Quantity:	240
Weight:	11 g

General Information

Series:	PHBC
Style:	Through-Hole
Features:	Switching Power Supply Outlet, DC-DC Converter, Phase Compensation, Noise Solution
RoHS:	Yes
Miscellaneous:	15 (K) Temperature Rise Max.

Specifications

Inductance:	38 uH (0.1 MHz)
Inductance Tolerance:	20%
Current:	3 A
Temperature Range:	-40/+125C
DC Resistance:	31.2 mOhms