

KEMET, PHBC, AC Line Filters, Normal Mode, 45 uH, 20%

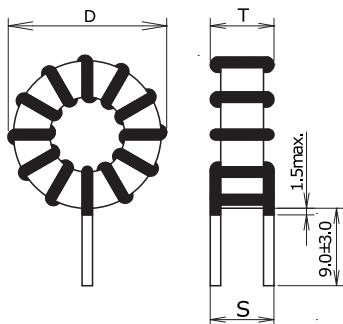

Dimensions	
D	30mm MAX
T	14.9mm MAX
LL	9mm +/-3mm
S	11mm NOM

Packaging Specifications	
Packaging:	Tray
Packaging Quantity:	150
Weight:	27 g

General Information	
Series:	PHBC
Style:	Through-Hole
Features:	Switching Power Supply Outlet, DC-DC Converter, Phase Compensation, Noise Solution
RoHS:	Yes
Miscellaneous:	25 (K) Temperature Rise Max.

Specifications	
Inductance:	45 uH (0.1 MHz)
Inductance Tolerance:	20%
Current:	6 A
Temperature Range:	-40/+125C
DC Resistance:	18.3 mOhms