

KEMET, SHBC, AC Line Filters, Normal Mode, 127 uH, 20%

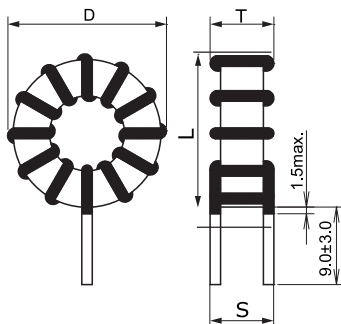

Dimensions	
D	30mm MAX
L	30mm MAX
T	30mm MAX
LL	9mm +/-3mm
S	12mm NOM

Packaging Specifications	
Packaging:	Tray
Packaging Quantity:	150
Weight:	30 g

General Information	
Series:	SHBC
Style:	Through-Hole
Features:	Low Core Loss, High Frequency Drive
RoHS:	Yes
Miscellaneous:	35 (K) Temperature Rise Max.

Specifications	
Inductance:	127 uH
Inductance Tolerance:	20%
Current:	6 A
Temperature Range:	-40/+125C
DC Resistance:	31.7 mOhms