

KEMET, SHBC, AC Line Filters, Normal Mode, 67 uH, 20%

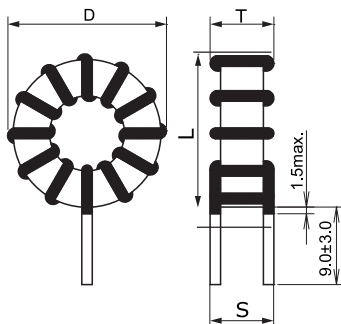

Dimensions	
D	33.5mm MAX
L	33.5mm MAX
T	33.5mm MAX
LL	9mm +/-3mm
S	14mm NOM

Packaging Specifications	
Packaging:	Tray
Packaging Quantity:	120
Weight:	37 g

General Information	
Series:	SHBC
Style:	Through-Hole
Features:	Low Core Loss, High Frequency Drive
RoHS:	Yes
Miscellaneous:	40 (K) Temperature Rise Max.

Specifications	
Inductance:	67 uH
Inductance Tolerance:	20%
Current:	8 A
Temperature Range:	-40/+125C
DC Resistance:	22.2 mOhms