

KEMET, SHBC, AC Line Filters, Normal Mode, 54 uH, 20%

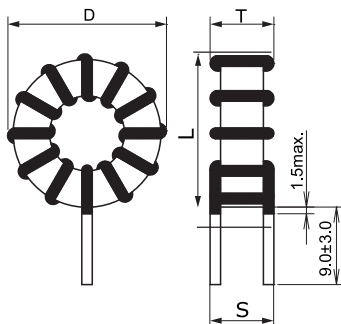

Dimensions	
D	41.2mm MAX
L	41.2mm MAX
T	41.2mm MAX
LL	9mm +/-3mm
S	14mm NOM

Packaging Specifications	
Packaging:	Tray
Packaging Quantity:	80
Weight:	56 g

General Information	
Series:	SHBC
Style:	Through-Hole
Features:	Low Core Loss, High Frequency Drive
RoHS:	Yes
Miscellaneous:	36 (K) Temperature Rise Max.

Specifications	
Inductance:	54 uH
Inductance Tolerance:	20%
Current:	12 A
Temperature Range:	-40/+125C
DC Resistance:	11.5 mOhms