

KEMET, SHBC, AC Line Filters, Normal Mode, 104 uH, 20%

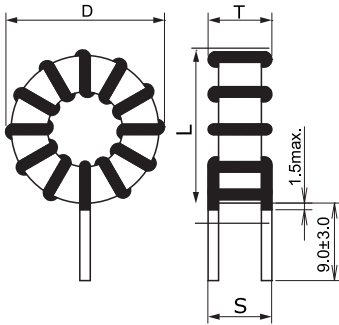

Dimensions	
D	49.5mm MAX
L	49.5mm MAX
T	49.5mm MAX
LL	9mm +/-3mm
S	22mm NOM

Packaging Specifications	
Packaging:	Tray
Packaging Quantity:	60
Weight:	133 g

General Information	
Series:	SHBC
Style:	Through-Hole
Features:	Low Core Loss, High Frequency Drive
RoHS:	Yes
Miscellaneous:	55 (K) Temperature Rise Max.

Specifications	
Inductance:	104 uH
Inductance Tolerance:	20%
Current:	20 A
Temperature Range:	-40/+125C
DC Resistance:	10.4 mOhms