

KEMET, SHBC, AC Line Filters, Normal Mode, 39 uH, 20%

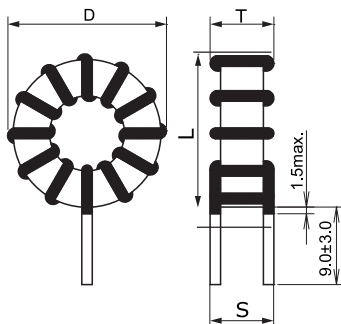

Dimensions	
D	50.1mm MAX
L	50.1mm MAX
T	50.1mm MAX
LL	9mm +/-3mm
S	20mm NOM

Packaging Specifications	
Packaging:	Tray
Packaging Quantity:	60
Weight:	135 g

General Information	
Series:	SHBC
Style:	Through-Hole
Features:	Low Core Loss, High Frequency Drive
RoHS:	Yes
Miscellaneous:	50 (K) Temperature Rise Max.

Specifications	
Inductance:	39 uH
Inductance Tolerance:	20%
Current:	30 A
Temperature Range:	-40/+125C
DC Resistance:	6.8 mOhms