

KEMET, SHBC, AC Line Filters, Normal Mode, 65 uH, 20%

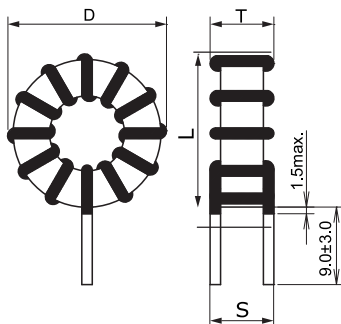

Dimensions	
D	57.6mm MAX
L	57.6mm MAX
T	57.6mm MAX
LL	9mm +/-3mm
S	23mm NOM

Packaging Specifications	
Packaging:	Tray
Packaging Quantity:	45
Weight:	217 g

General Information	
Series:	SHBC
Style:	Through-Hole
Features:	Low Core Loss, High Frequency Drive
RoHS:	Yes
Miscellaneous:	50 (K) Temperature Rise Max.

Specifications	
Inductance:	65 uH
Inductance Tolerance:	20%
Current:	30 A
Temperature Range:	-40/+125C
DC Resistance:	6.2 mOhms