

T520, Tantalum, Polymer Tantalum, 330 uF, 20%, 2.5 VDC, SMD, Polymer, Molded, Low Profile/ESR, NonCombustible, 40 mOhms, 7343, Height Max = 1.9mm

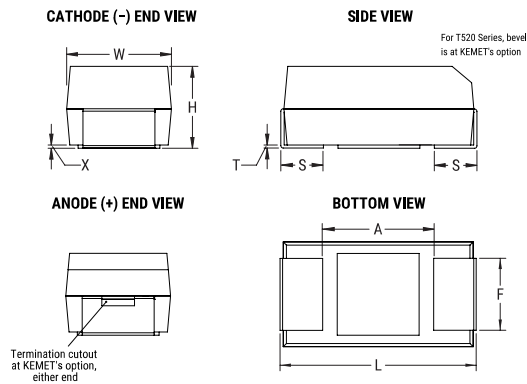

| General Information | |
|---------------------|---|
| Supplier: | KEMET |
| Series: | T520 |
| Dielectric: | Polymer Tantalum |
| Style: | SMD Chip |
| Description: | SMD, Polymer, Molded, Low Profile/ESR, NonCombustible |
| Features: | Low ESR |
| RoHS: | Yes |
| Termination: | Tin |
| Shelf Life: | 52 Weeks |
| MSL: | 3 |

| Dimensions | |
|------------|----------------|
| Footprint | 7343 |
| L | 7.3mm +/-0.3mm |
| W | 4.3mm +/-0.3mm |
| H | 1.8mm +/-0.1mm |
| T | 0.13mm REF |
| S | 1.3mm +/-0.3mm |
| F | 2.4mm +/-0.1mm |
| A | 3.6mm MIN |
| X | 0.05mm REF |

| Specifications | |
|------------------------|--|
| Capacitance: | 330 uF |
| Capacitance Tolerance: | 20% |
| Voltage DC: | 2.5 VDC (105C) |
| Temperature Range: | -55/+105C |
| Rated Temperature: | 105C |
| Dissipation Factor: | 10.00% 120Hz 25C |
| Failure Rate: | N/A |
| Resistance: | 40 mOhms (100kHz 25C) |
| Ripple Current: | 2200 mA (100kHz 45C), 1540 mA (85C), 550 mA (105C) |
| Leakage Current: | 82.5 uA (5min 25C) |

| Packaging Specifications | |
|--------------------------|------------|
| Weight: | 274.3 mg |
| Packaging: | T&R, 178mm |
| Packaging Quantity: | 1000 |

Statements of suitability for certain applications are based on our knowledge of typical operating conditions for such applications, but are not intended to constitute - and we specifically disclaim - any warranty concerning suitability for a specific customer application or use. This Information is intended for use only by customers who have the requisite experience and capability to determine the correct products for their application. Any technical advice inferred from this Information or otherwise provided by us with reference to the use of our products is given gratis, and we assume no obligation or liability for the advice given or results obtained.