

KEMET Part Number: FC0H104ZFTBR24
(USCFC00H104ZBC)

FC, Supercapacitors, SMD Can, Commercial Grade, 0.1 F, -20/+80%, 5.5 VDC, V-Chip

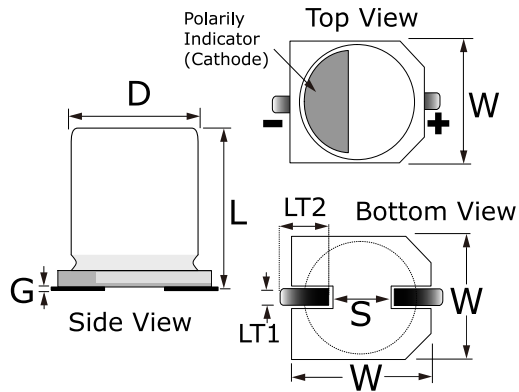

Dimensions	
D	10.5mm +/-0.5mm
L	5.5mm MAX
W	10.8mm +/-0.2mm
S	5mm NOM
G	0mm +0.3/-0.1mm
LT1	1.2mm +/-0.1mm
LT2	3.6mm +0.5mm

Packaging Specifications	
Lead:	V-Chip
Packaging:	T&R, 380mm

General Information	
Supplier:	KEMET
Series:	FC
Description:	Surface Mount Double Layer Capacitor
Features:	Ultra Low ESR, High Power Pulse
RoHS:	Yes

Specifications	
Capacitance:	0.1 F
Capacitance Tolerance:	-20/+80%
Voltage DC:	5.5 VDC, 4.2 VDC (Holding Voltage)
Temperature Range:	-25/+70C
Rated Temperature:	70C
Resistance:	25000 mOhms (1kHz)
Ripple Current:	0.15 mAmps (30min)